

Bắt đầu ngắt Vùng nghèo

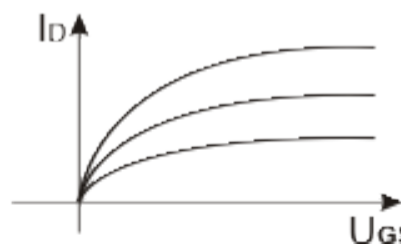

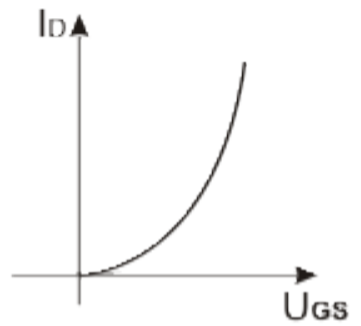

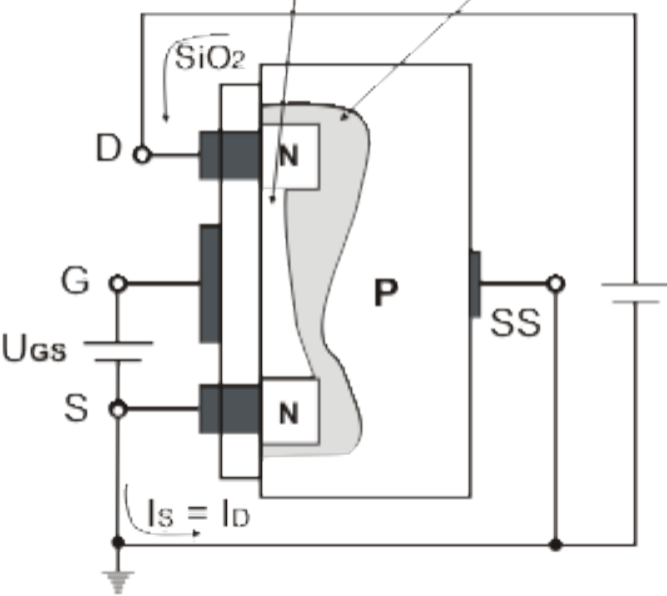

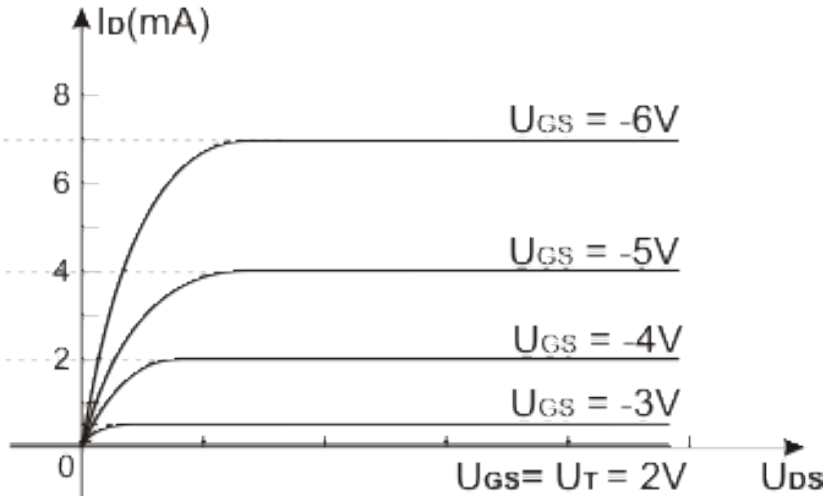
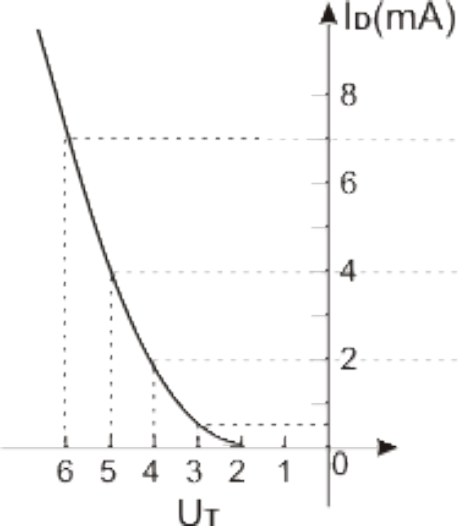
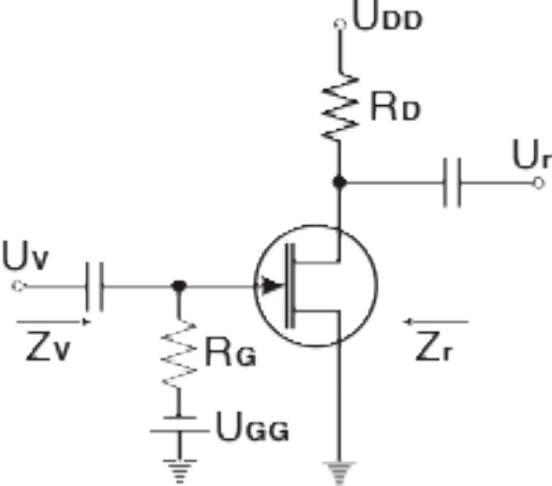
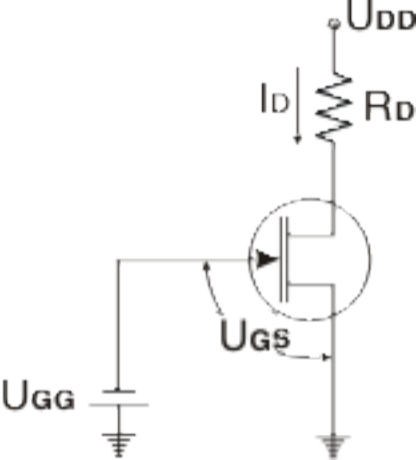

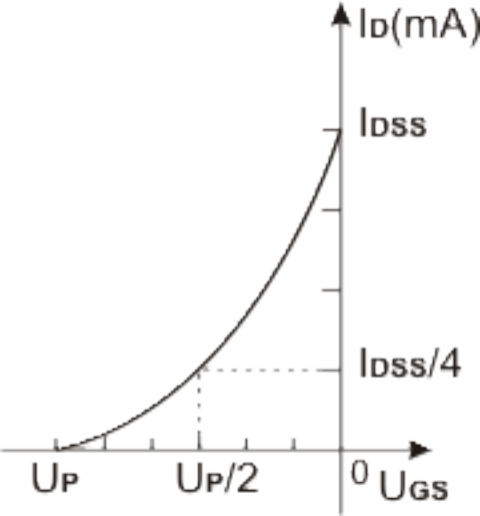

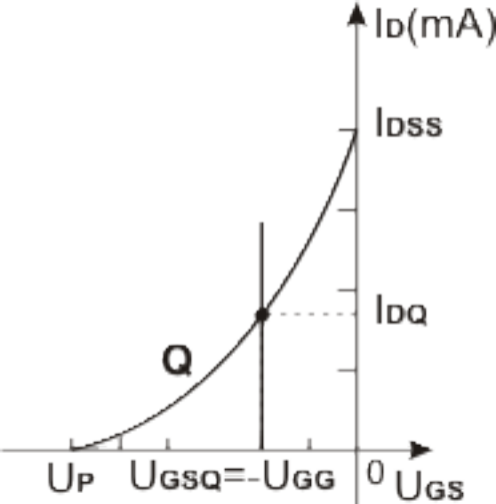

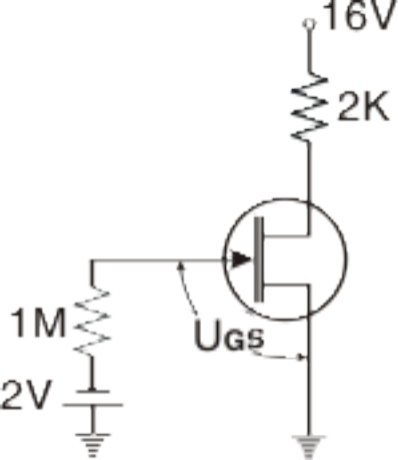

$$I_{DSS} = 10\text{mA}$$

$$U_P = -8\text{V}$$

