

CD/DVD Player

Operating Instructions



DVP-NS300

WARNING

To prevent fire or shock hazard, do not expose the unit to rain or moisture.

To avoid electrical shock, do not open the cabinet. Refer servicing to qualified personnel only.

CAUTION

The use of optical instruments with this product will increase eye hazard. As the laser beam used in this CD/DVD player is harmful to eyes, do not attempt to disassemble the cabinet.

Refer servicing to qualified personnel only.



This symbol is intended to alert the user to the presence of uninsulated "dangerous voltage" within the product's enclosure that may be of sufficient magnitude to constitute a risk of electric shock to persons.



This symbol is intended to alert the user to the presence of important operating and maintenance (servicing) instructions in the literature accompanying the appliance.

CAUTION

TO PREVENT ELECTRIC SHOCK MATCH WIDE BLADE OF PLUG TO WIDE SLOT, FULLY INSERT.

For customers in the U.S.A

Owner's Record

The model and serial numbers are located at the rear of the unit. Record the serial number in the space provided below. Refer to them whenever you call upon your Sony dealer regarding this product.

Model No. DVP-NS300
Serial No. _____

CAUTION

You are cautioned that any change or modifications not expressly approved in this manual could void your authority to operate this equipment.

Note

This equipment has been tested and found to comply with the limits for a Class B digital device, pursuant to Part 15 of the FCC Rules. These limits are designed to provide reasonable protection against harmful interference in a residential installation. This equipment generates, uses, and can radiate radio frequency energy and, if not installed and used in accordance with the instructions, may cause harmful interference to radio communications. However, there is no guarantee that interference will not occur in a particular installation. If this equipment does cause harmful interference to radio or television reception, which can be determined by turning the equipment off and on, the user is encouraged to try to correct the interference by one or more of the following measures:

- Reorient or relocate the receiving antenna.
- Increase the separation between the equipment and receiver.
- Connect the equipment into an outlet on a circuit different from that to which the receiver is connected.
- Consult the dealer or an experienced radio/TV technician for help.

Welcome!

Thank you for purchasing this Sony CD/DVD Player. Before operating the player, please read this manual thoroughly and retain it for future reference.

Precautions

On safety

- The power requirements and power consumption of this player are indicated on the back of the player. Check that the player's operating voltage is identical with your local power supply.

Power requirements and power consumption →



- Caution – The use of optical instruments with this product will increase eye hazard.
- Should any solid object or liquid fall into the cabinet, unplug the player and have it checked by qualified personnel before operating it any further.

On power sources

- The player is not disconnected from the AC power source as long as it is connected to the wall outlet, even if the player itself has been turned off.
- If you are not going to use the player for a long time, be sure to disconnect the player from the wall outlet. To disconnect the AC power cord, grasp the plug itself; never pull the cord.
- Should the AC power cord need to be changed, have it done at a qualified service shop only.

On placement

- Place the player in a location with adequate ventilation to prevent heat build-up in the player.
- Do not place the player on a soft surface such as a rug that might block the ventilation holes on the bottom.
- Do not place the player in a location near heat sources, or in a place subject to direct sunlight, excessive dust, or mechanical shock.

On operation

- If the player is brought directly from a cold to a warm location, or is placed in a very damp room, moisture may condense on the lenses inside the player. Should this occur, the player may not operate properly. In this case, remove the disc and leave the player turned on for about half an hour until the moisture evaporates.
- When you move the player, take out any discs. If you don't, the disc may be damaged.

On adjusting volume

Do not turn up the volume while listening to a section with very low level inputs or no audio signals. If you do, the speakers may be damaged when a peak level section is played.

On cleaning

Clean the cabinet, panel, and controls with a soft cloth slightly moistened with a mild detergent solution. Do not use any type of abrasive pad, scouring powder or solvent such as alcohol or benzene.

If you have any questions or problems concerning your player, please consult your nearest Sony dealer.

On cleaning discs

Do not use a commercially available CD/DVD cleaning disc. It may cause a malfunction.

IMPORTANT NOTICE

Caution: The enclosed DVD player is capable of holding a still video image or on-screen display image on your television screen indefinitely. If you leave the still video image or on-screen display image displayed on your TV for an extended period of time you risk permanent damage to your television screen. Projection televisions are especially susceptible to this.

For the model supplied with the AC plug adaptor

If the AC plug of your unit does not fit into the wall outlet, attach the supplied AC plug adaptor.

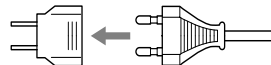





Table of Contents

WARNING	2
Welcome!	2
Precautions	3
About this Manual	6
This Player Can Play the Following Discs	6
Notes about the Discs	7
Index to Parts and Controls	8
Guide to On-Screen Displays (Status Bar, Control Bar, Control Menu)	12
<hr/>	
Getting Started	14
Quick Overview	14
Step 1: Unpacking	14
Step 2: Inserting Batteries into the Remote	14
Step 3: TV Hookups	15
Step 4: Playing a Disc	16
<hr/>	
Hookups	17
Hooking Up the Player	17
Step 1: Connecting the Video Cords	17
Step 2: Connecting the Audio Cords	19
Step 3: Connecting the Power Cord	24
Step 4: Quick Setup	24
<hr/>	
Playing Discs	28
Playing Discs	28
Resuming Playback from the Point Where You Stopped the Disc (Resume Play)	30
Using the DVD's Menu	31
Playing VIDEO CDs with PBC Functions (PBC Playback)	32
Various Play Mode Functions (Program Play, Shuffle Play, Repeat Play, A-B Repeat Play)	33
<hr/>	
Searching for a Scene	37
Searching for a Particular Point on a Disc (Scan, Slow-motion Play)	37
Searching for a Title/Chapter/Track/Index/Scene (Search mode)	38
<hr/>	
Viewing Information About the Disc	39
Checking the Playing Time and Remaining Time on the Front Panel Display	39
Checking the Playing Time and Remaining Time	40



Sound Adjustments	42
Changing the Sound	42
TV Virtual Surround Sound Settings (TVS)	43
<hr/>	
Enjoying Movies	45
Changing the Angles	45
Displaying the Subtitles	45
Adjusting the Picture Quality (BNR)	46
<hr/>	
Using Various Additional Functions	47
Locking Discs (Custom Parental Control, Parental Control)	47
Operation Sound Effects (Sound Feedback)	52
Controlling Your TV with the Supplied Remote	53
<hr/>	
Settings and Adjustments	54
Using the Setup Display	54
Setting the Display or Sound Track Language (LANGUAGE SETUP)	55
Settings for the Display (SCREEN SETUP)	56
Custom Settings (CUSTOM SETUP)	57
Settings for the Sound (AUDIO SETUP)	58
<hr/>	
Additional Information	61
Troubleshooting	61
Self-diagnosis Function (When letters/numbers appear in the display)	63
Glossary	64
Specifications	66
Language Code List	67
List of Setup Display Items	68
Index	70

About this Manual

- Instructions in this manual describe the controls on the remote. You can also use the controls on the player if they have the same or similar names as those on the remote.
- The icons used in this manual are described below:

Icon	Meaning	Icon	Meaning
	Functions available in DVD video mode		Functions available in music CD mode
	Functions available in VIDEO CD mode		More convenient features

This Player Can Play the Following Discs

Format of discs	
DVD VIDEO	
VIDEO CD	
Music CD	

The “DVD VIDEO” logo is a trademark.

Region code

Your DVD player has a region code printed on the back of the unit and will only play DVDs labeled with identical region codes.

DVDs labeled  will also play on this player.

If you try to play any other DVD, the message “Playback prohibited by area limitations.” will appear on the TV screen. Depending on the DVD, no region code indication may be labeled even though playing the DVD is prohibited by area restrictions.



Example of discs that the player cannot play

The player cannot play the following discs:

- CD-ROMs (PHOTO CDs included)
- CD-Rs
- Data part of CD-Extras
- DVD-ROMs
- DVD Audio discs
- HD layer on SACDs

Also, the player cannot play the following discs:

- A DVD with a different region code (page 64).
- A disc recorded in a color system other than NTSC, such as PAL or SECAM. (This player conforms to the NTSC color system.)
- A disc that has a non-standard shape (e.g., card, heart).
- A disc with paper or stickers on it.
- A disc that has the adhesive of cellophane tape or a sticker still left on it.

Note on playback operations of DVDs and VIDEO CDs

Some playback operations of DVDs and VIDEO CDs may be intentionally set by software producers. Since this player plays DVDs and VIDEO CDs according to the disc contents the software producers designed, some playback features may not be available. Also, refer to the instructions supplied with the DVDs or VIDEO CDs.

Copyrights

This product incorporates copyright protection technology that is protected by method claims of certain U.S. patents, other intellectual property rights owned by Macrovision Corporation, and other rights owners. Use of this copyright protection technology must be authorized by Macrovision Corporation, and is intended for home and other limited viewing uses only unless otherwise authorized by Macrovision Corporation. Reverse engineering or disassembly is prohibited.

Notes about the Discs

On handling discs

- To keep the disc clean, handle the disc by its edge. Do not touch the surface.

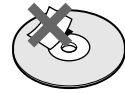

- Do not expose the disc to direct sunlight or heat sources such as hot air ducts, or leave it in a car parked in direct sunlight as the temperature may rise considerably inside the car.
- After playing, store the disc in its case.

On cleaning

- Before playing, clean the disc with a cleaning cloth. Wipe the disc from the center out.



- Do not use solvents such as benzine, thinner, commercially available cleaners, or anti-static spray intended for vinyl LPs.

Index to Parts and Controls

For more information, refer to the pages indicated in parentheses.

Front Panel

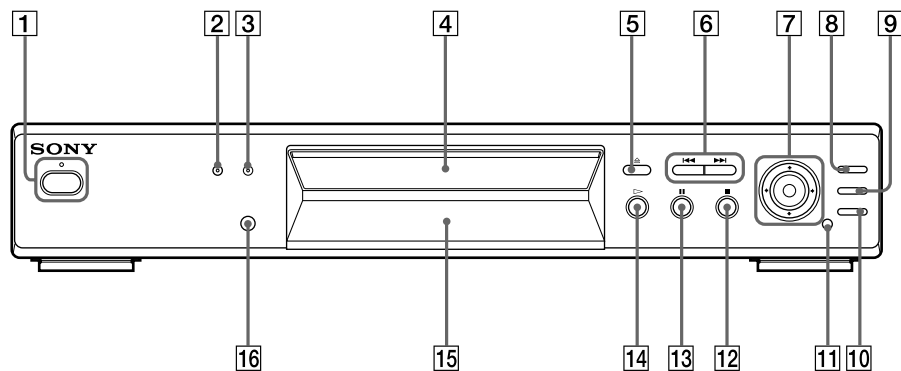

- | | |
|--|--------------------------------------|
| 1 POWER switch/indicator (28) | 10 ↶ ↷ RETURN button (32) |
| 2 BNR (Block Noise Reduction) button/
indicator (46) | 11 DISPLAY button (12) |
| 3 SURROUND button/indicator (43) | 12 ■ (stop) button (28) |
| 4 Disc tray (28) | 13 (pause) button (29, 52) |
| 5 ⏏ (open/close) button (28) | 14 ▷ (play) button (28) |
| 6 ⏮/⏭ (previous/next) buttons (29) | 15 Front panel display (9) |
| 7 ⏪/⏩/⏴/⏵/ENTER buttons (24) | 16 📶 (remote sensor) (14) |
| 8 TITLE button (31) | |
| 9 DVD MENU button (31) | |

Front Panel Display

When playing back a DVD

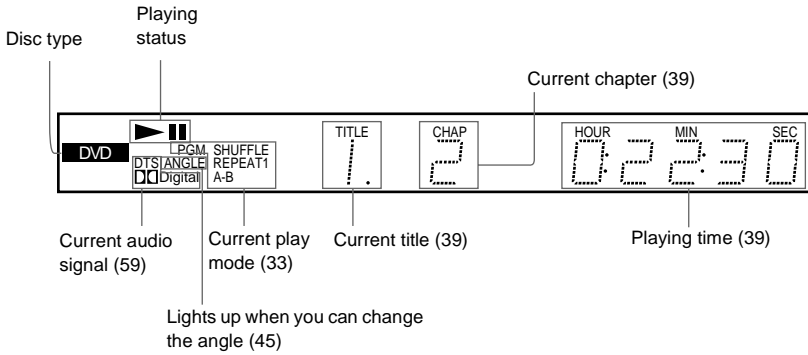

When playing back a VIDEO CD (PBC)

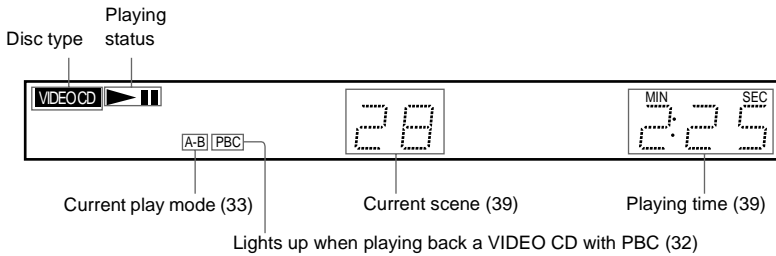

When playing back a CD or VIDEO CD (without PBC)

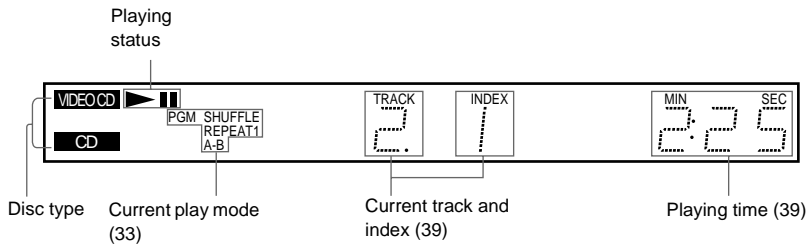

Rear Panel

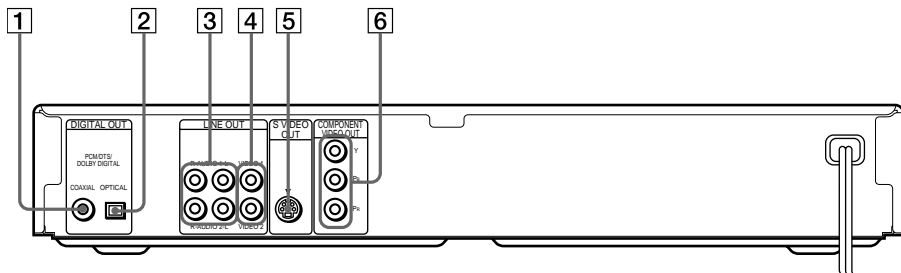

- 1** DIGITAL OUT (COAXIAL) jack (21, 22, 23)
- 2** DIGITAL OUT (OPTICAL) jack (21, 22, 23)
- 3** LINE OUT L/R (AUDIO) 1/2 jacks (20, 21, 22)

- 4** LINE OUT (VIDEO) 1/2 jacks (17)
- 5** S VIDEO OUT jack (17)
- 6** COMPONENT VIDEO OUT jacks (17)

Remote

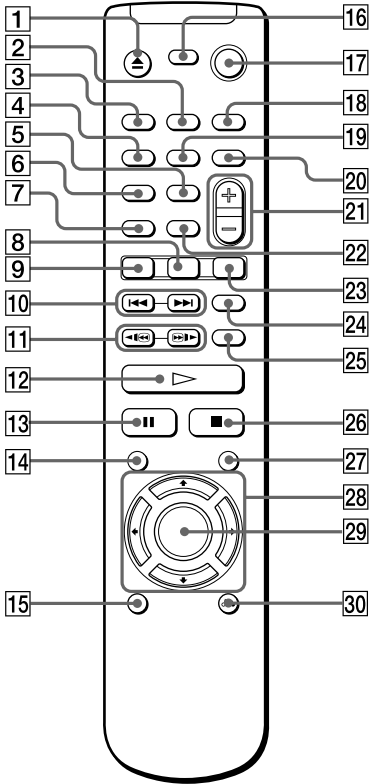

- 1** ▲ OPEN/CLOSE button (28)
- 2** BNR (Block Noise Reduction) button (46)
- 3** SURROUND button (43)
- 4** TIME/TEXT button (39)
- 5** REPEAT button (35)
- 6** SHUFFLE button (35)
- 7** PROGRAM button (35)
- 8** ANGLE button (45)
- 9** AUDIO button (42)
- 10** ◀◀/▶▶ PREV/NEXT buttons (29)
- 11** ◀◀◀/▶▶▶ SCAN/SLOW buttons (37)
- 12** ▷ PLAY button (28)
- 13** ■ PAUSE button (28)
- 14** TITLE button (31)
- 15** DISPLAY button (54)
- 16** TV I/⏻ (on/standby) button (53)
- 17** I/⏻ (on/standby) button (53)
- 18** SETUP button (54)
- 19** A - B button (36)
- 20** TV/VIDEO button (53)
- 21** VOL +/- button (53)
- 22** CLEAR button (33)
- 23** SUBTITLE button (45)
- 24** SEARCH MODE button (38)
- 25** INSTANT REPLAY button (53)
- 26** ■ STOP button (28)
- 27** DVD MENU button (31)
- 28** ←/↑/↓/→ buttons (24)
- 29** ENTER button
- 30** ⌂ RETURN button (32)

Guide to On-Screen Displays (Status Bar, Control Bar, Control Menu)

The following explains the three type of on-screen displays used with this player: Status Bar, and Control Bar, and Control Menu.

Status Bar

Displays the current playing status

This display appears when the DISPLAY button is pressed repeatedly during playback. The numbers in parentheses indicate reference pages.

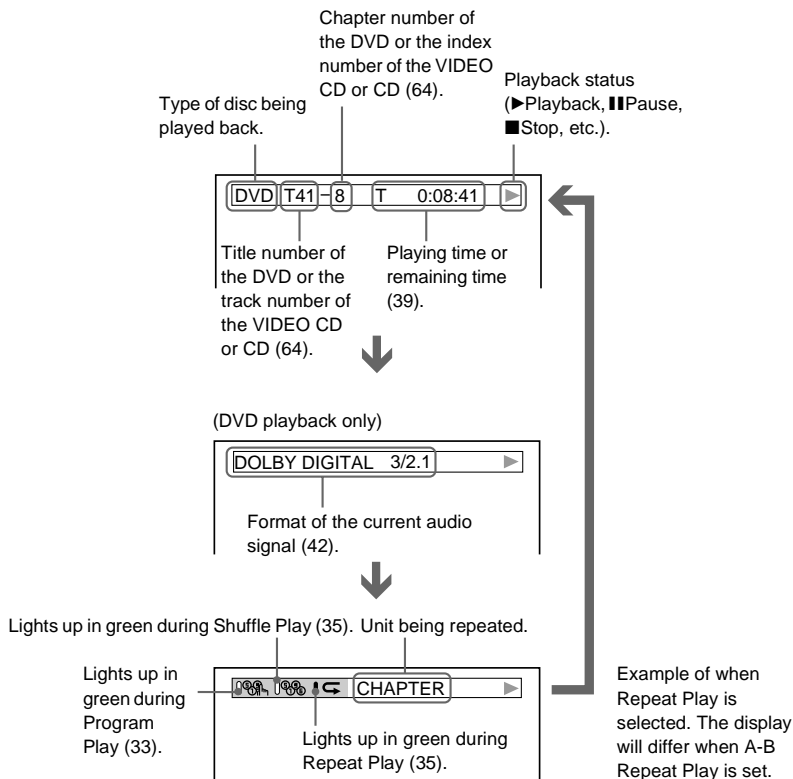

Control Bar

The Control Bar appears when a playback function is selected by pressing the function's button on the remote.

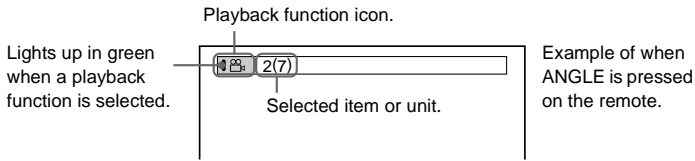

Control Menu

The Control Menu appears when the DISPLAY button is pressed when the player is in stop mode. The number in parenthesis indicate reference pages.

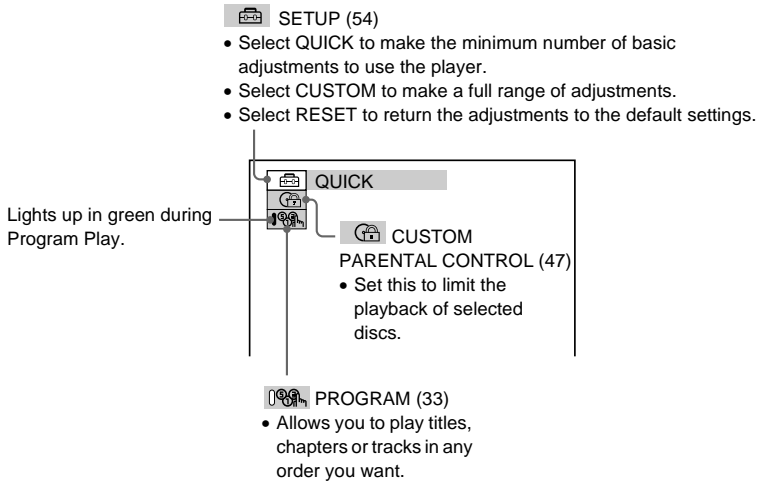

Quick Overview

A quick overview presented in this chapter will give you enough information to start using the player for your enjoyment. To use the surround sound features of this player, refer to “Hookups” on page 17.

Note

You cannot connect this player to a TV that does not have a video input jack. Be sure to turn off the power of each component before connecting.

Step 1: Unpacking

Check that you have the following items:

- Audio/video cord (pinplug × 3 ↔ pinplug × 3) (1)
- Remote commander (remote) RMT-D126A (1)
- Size AA (R6) batteries (2)
- A plug adaptor is included with some models.

Step 2: Inserting Batteries into the Remote

You can control the player using the supplied remote. Insert two size AA (R6) batteries by matching the ⊕ and ⊖ ends on the batteries to the markings inside the compartment. When using the remote, point it at the remote sensor  on the player.

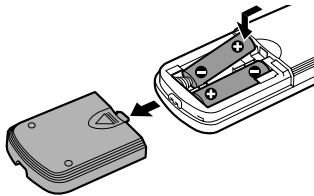

Notes

- Do not leave the remote in an extremely hot or humid place.
- Do not drop any foreign object into the remote casing, particularly when replacing the batteries.
- Do not expose the remote sensor to direct light from the sun or lighting apparatus. Doing so may cause a malfunction.
- If you do not use the remote for an extended period of time, remove the batteries to avoid possible damage from battery leakage and corrosion.

Step 3: TV Hookups

Connect the supplied audio/video cord and power cord in the order (1~3) shown below. Be sure to connect the power cord last.

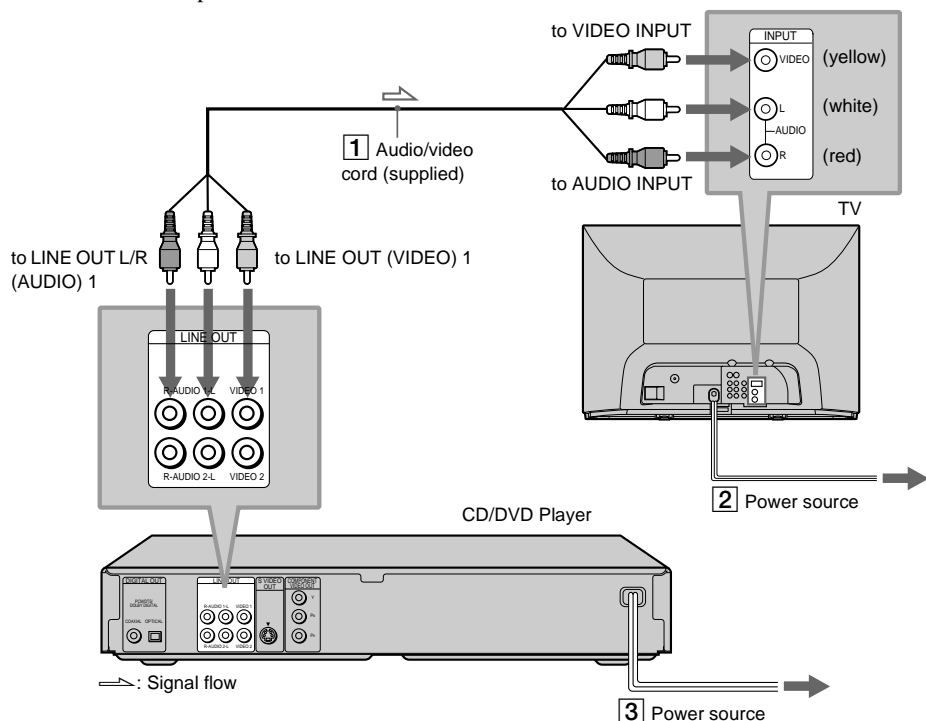

When connecting to a wide screen TV

Depending on the disc, the image may not fit your TV screen.

If you want to change the aspect ratio, please refer to page 56.

Step 4: Playing a Disc

- 1 Turn on the TV.
- 2 Switch the input selector on the TV to the player.

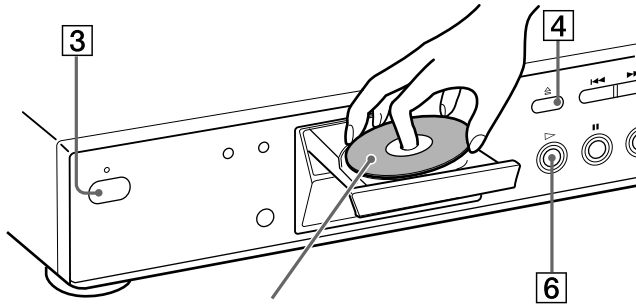

- 3 Press **POWER** on the player.
- 4 Press \triangle on the player to open the disc tray.
- 5 Place the disc on the tray with the playback side facing down.
- 6 Press \blacktriangleright .
The disc tray closes and the player begins playing the disc.

After Step 6

Depending on the disc, a menu may be displayed on the TV screen. If so, select the item you want from the menu and play the DVD (page 31) or VIDEO CD disc (page 32).

To stop playing

Press \blacksquare .

To take out the disc

Press \triangle .

To turn off the player

Press I/O on the remote. The player is set to standby mode and the power indicator lights up in red. Press **POWER** on the player to turn off completely.

Hooking Up the Player

Follow Steps 1 to 4 to hook up and adjust the settings of the player.

Before you start, turn off the power, check that you have all of the supplied accessories, and insert the batteries into the remote (page 14).

Notes

- Plug cords securely to prevent unwanted noise.
- Refer to the instructions supplied with the components to be connected.

Step 1: Connecting the Video Cords

Connect your CD/DVD player to your TV monitor, projector, or AV amplifier (receiver) using a video cord. Select one of the patterns **A** through **C**, according to the input jack on your TV monitor, projector, or AV amplifier (receiver).

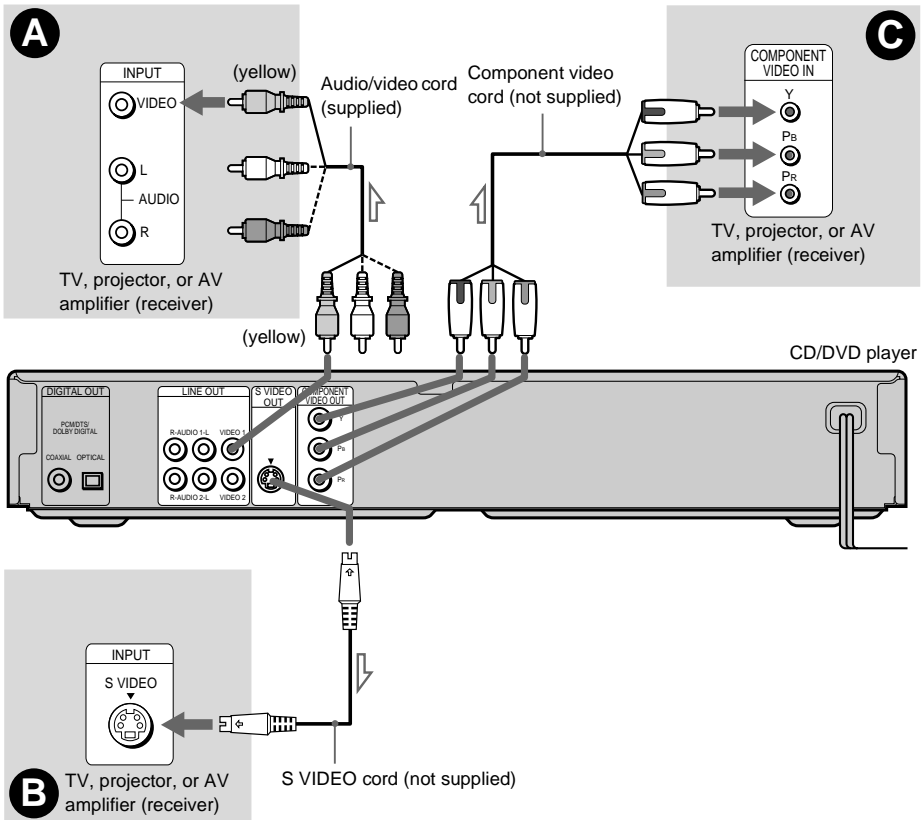

→ : Signal flow

continued

A If you are connecting to a video input jack

Connect the yellow plug of the audio/video cord (supplied) to the yellow (video) jacks. You will enjoy standard quality images.

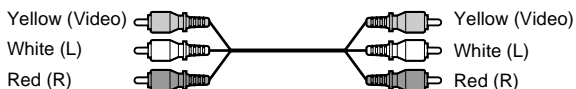

Use the red and white plugs to connect to the audio input jacks (page 19).

B If you are connecting to an S VIDEO input jack

Connect the S VIDEO cord (not supplied). You will enjoy high quality images.



C If you are connecting to a monitor, projector, or AV amplifier (receiver) having component video input jacks (Y, P_B, P_R)

Connect the component via the COMPONENT VIDEO OUT jacks using a component video cord (not supplied) or three video cords (not supplied) of the same kind and length. You will enjoy accurate color reproduction and high quality images.

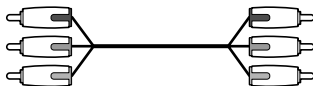

Note

Do not connect your player to a VCR. You may not receive a clear image on the TV screen if you pass the player signals via the VCR.

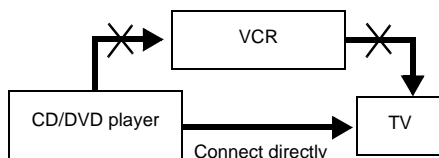

Step 2: Connecting the Audio Cords

Refer to the chart below to select the connection that best suits your system. The surround effects you will enjoy depend on the connections and components you use.

Select a connection

Select one of the following connections, **A** through **D**.

Connection	Components to be connected
A (page 20)	<ul style="list-style-type: none"> • TV (stereo)
B (page 21)	<ul style="list-style-type: none"> • Stereo amplifier (receiver) (having L and R audio input jacks only, or having a digital input jack) • 2 speakers (front L and R)
B (page 21)	<ul style="list-style-type: none"> • MD deck/DAT deck
C (page 22)	<ul style="list-style-type: none"> • AV amplifier (receiver) with a Dolby* Surround (Pro Logic) decoder (having L and R audio input jacks only, or having a digital input jack) • 3 speakers (front L and R, and rear (monaural)) • 6 speakers (front L and R, center, rear L and R, and subwoofer)
D (page 23)	<ul style="list-style-type: none"> • AV amplifier (receiver) having a Dolby Digital or DTS** decoder and a digital input jack • 6 speakers (front L and R, rear L and R, center, and subwoofer)

* Manufactured under license from Dolby Laboratories. "Dolby," "Pro Logic," and the double-D symbol are trademarks of Dolby Laboratories. Confidential unpublished works. © 1992-1997 Dolby Laboratories. All rights reserved.

** "DTS" is a registered trademark of Digital Theater Systems, Inc.

A Connecting to your TV

This connection will use your TV speakers for sound.

■ Recommended surround sound effects for this connection

- TVS DYNAMIC (page 43)
- TVS WIDE (page 43)

CD/DVD player

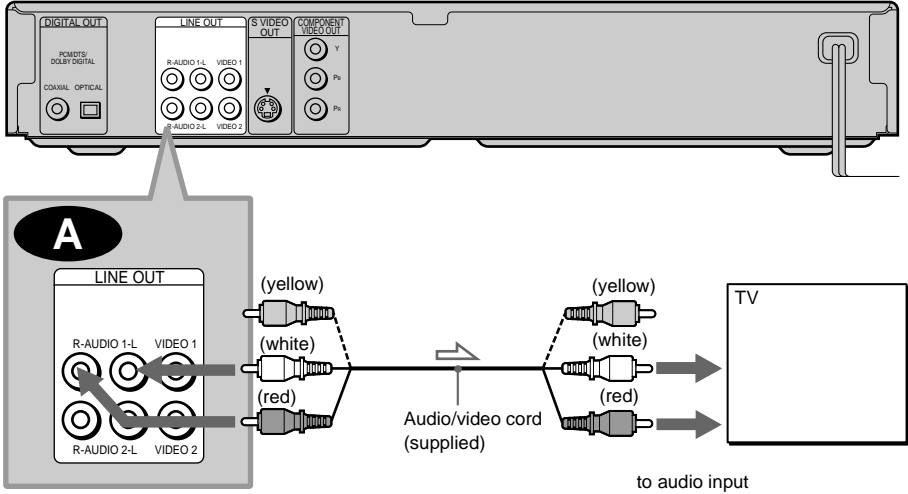

⇒ : Signal flow

The yellow plug is used for video signals (page 17).

B Connecting to a stereo amplifier (receiver) and 2 speakers/Connecting to an MD deck or DAT deck

This connection will use your 2 front speakers connected to your stereo amplifier (receiver) for sound. If the stereo amplifier (receiver) has audio input jacks L and R only, use **B-1**. If the amplifier (receiver) has a digital input jack, use **B-2**. When connecting to an MD deck or a DAT deck, use **B-2**. In this case, you can also connect the player directly to the MD deck or DAT deck without using your stereo amplifier (receiver).

- Recommended surround sound effects for the **B-1** connection only
 - TVS STANDARD (page 43)

💡 In connection **B-1**, you can use the supplied audio/video cord instead of using a separate audio cord.

💡 To realize better surround sound effects, make sure that your listening position is in between your speakers.

Note

If you select one of the TVS effects while playing a disc, no sound will come from your speakers with the **B-2** connection.

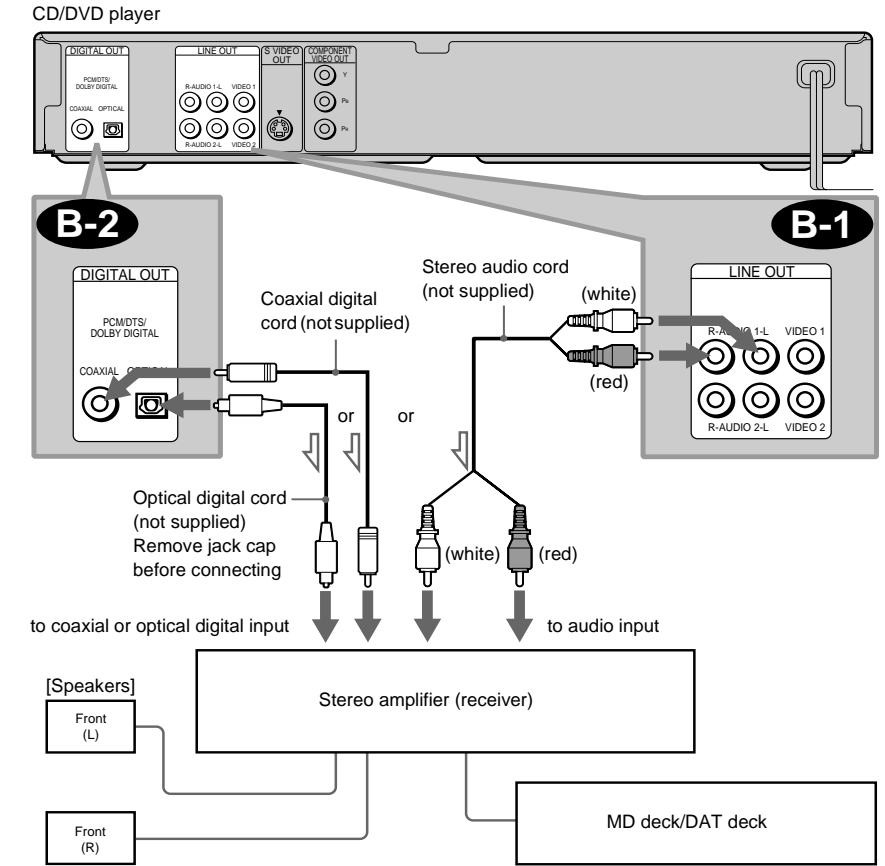

continued

C Connecting to a Dolby Surround (Pro Logic) decoder amplifier (receiver) and 3 to 6 speakers

This connection will allow you to enjoy the surround effects of the Pro Logic decoder on your amplifier (receiver). If you have an AV amplifier (receiver) equipped with a Dolby Digital, or DTS decoder, refer to page 23.

You can enjoy the Dolby Surround effects only when playing Dolby Surround audio or multi-channel audio (Dolby Digital) discs.

Pro Logic uses a minimum of 3 speakers (front L and R, and rear (monaural)). The surround effects are enhanced if 6 speakers (front L and R, center, rear L and R, and subwoofer) are used. If your amplifier (receiver) has R and L audio input jacks only, use **C-1**. If your amplifier (receiver) has a digital input jack, use **C-2**.

■ Recommended surround sound effects using this connection with your amplifier (receiver)

- Dolby Surround (Pro Logic) (page 64)

💡 For correct speaker setting location, please refer to the operating instructions of the amplifier (receiver).

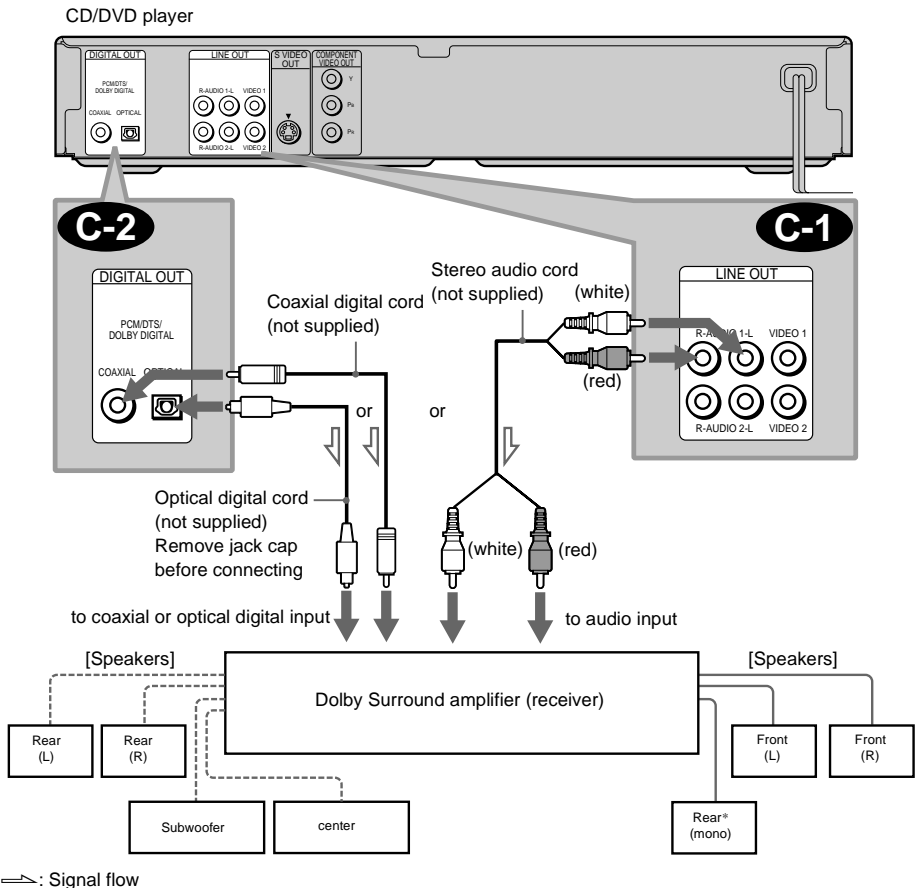

*When connecting 6 speakers, replace the monaural rear speaker with a center speaker, 2 rear speakers and a subwoofer.

D Connecting to an AV amplifier (receiver) with a digital input jack having a Dolby Digital, or DTS decoder, and 6 speakers

This connection will allow you to use the Dolby Digital, or DTS decoder function of your AV amplifier (receiver). You are not able to enjoy the TVS sound effects of the player.

■ Recommended surround sound effects using this connection with your amplifier (receiver)

- Dolby Digital (5.1ch) (page 64)
- DTS (5.1ch) (page 64)

💡 To enhance the surround sound effects, refer to the operating instructions of the amplifier (receiver) for correct speaker setting location.

Note

After you have completed the connection, be sure to set “DOLBY DIGITAL” to “DOLBY DIGITAL” (page 24). If your AV amplifier (receiver) has a DTS decoder, set “DTS” to “ON” (page 28). Otherwise, no sound or a loud noise will come from the speakers.

CD/DVD player

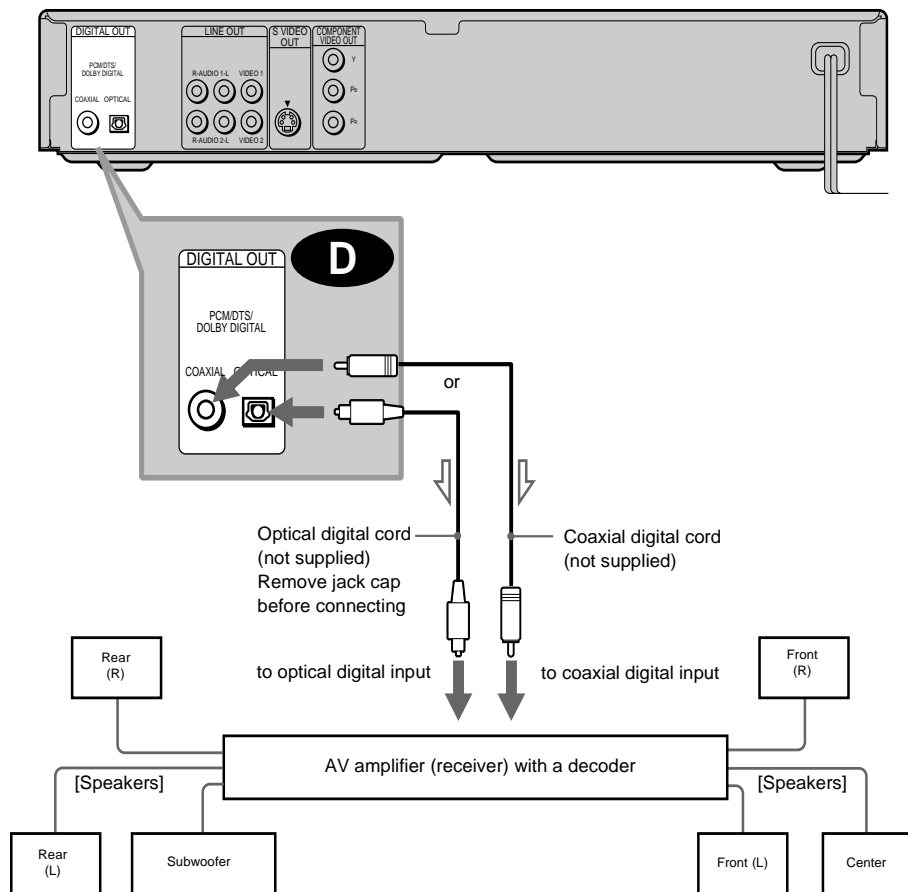

⇒ : Signal flow

Step 3: Connecting the Power Cord

Plug the player and TV power cords into an AC outlet.

Do not connect the power cord of your player to the “switched” power socket of an amplifier (receiver). Otherwise, when you turn off the power of your amplifier (receiver), the settings for the player may be lost.

Step 4: Quick Setup

Follow the steps below to make the minimum number of basic adjustments to use the player. To skip an adjustment, press **▶▶I**. To return to the previous adjustment, press **I◀◀**.

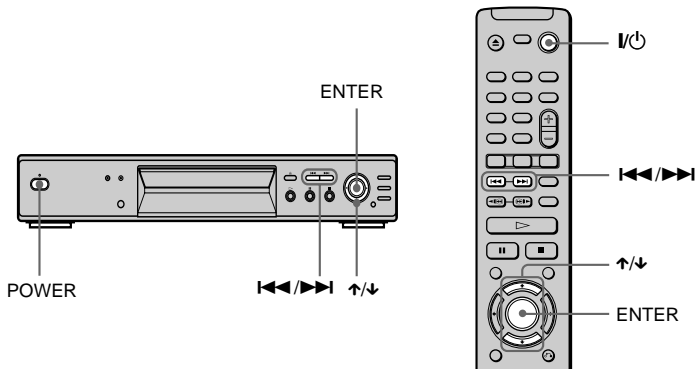

- 1 Turn on the TV.**
- 2 Switch the input selector on the TV to the player.**
- 3 Press POWER on the player and press I/⏻ on the remote.**
“Press [ENTER] to run QUICK SETUP” appears at the bottom of the screen. If this message does not appear, select “QUICK” under SETUP in the Control Menu (page 13) to run Quick Setup.
- 4 Press ENTER without inserting a disc.**
The Setup Display for selecting the language used in the on-screen display appears.

LANGUAGE SETUP	
OSD:	ENGLISH
DVD MENU:	ENGLISH
AUDIO:	FRENCH
SUBTITLE:	SPANISH
	PORTUGUESE

5 Press ↑/↓ to select a language.

The player uses the language selected here to display the DVD menu and subtitles as well.

6 Press ENTER.

The Setup Display for selecting the aspect ratio of the TV to be connected appears.

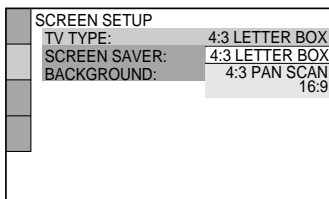

7 Press ↑/↓ to select the item.

TV type	You select	Page
4:3 standard TV	4:3 LETTER BOX or 4:3 PAN SCAN	56
A wide-screen TV or 4:3 standard TV with the wide-screen mode	16:9	56

8 Press ENTER.

The Setup Display for selecting the type of jack used to connect your amplifier (receiver) appears.

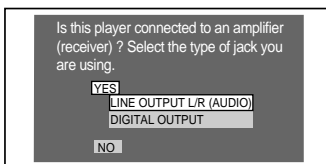

9 Press ↑/↓ to select the item, then press ENTER.

- When “NO” or “LINE OUTPUT L/R (AUDIO)” is selected, Quick Setup is finished and connections are complete.
- When “DIGITAL OUTPUT” is selected, the Setup Display for “DOLBY DIGITAL” appears. Proceed to Step **10**.

10 Press ↑/↓ to select the item.

Choose the item that matches the audio connection you selected in page 21 to 23 (**B** through **D**).

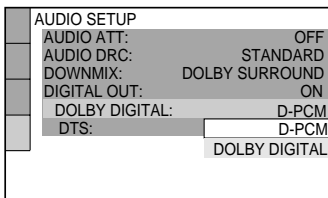

Audio Cord Connection Type	You select	Page
B-2 C-2	D-PCM	59
D	DOLBY DIGITAL (only if the amplifier/receiver has a Dolby Digital decoder)	59

11 Press **ENTER**.

DTS is selected.

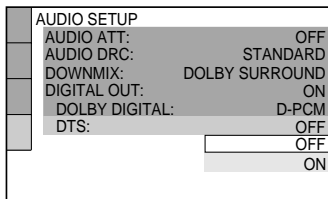

12 Press **↑/↓** to select the item.

Choose the item that matches the audio connection you selected in page 21 to 23 (**B** through **D**).

Audio Cord Connection Type	You select	Page
B-2 C-2	OFF	59
D	ON (only if the amplifier/receiver has a DTS decoder)	59

13 Press **ENTER**.

Quick Setup is finished. All connections and setup operations are complete.

Note

You can directly start Quick Setup only when you run it for the first time.

To run Quick Setup a second time, select "QUICK" under SETUP in the Control Menu (page 54).

Enjoying the surround sound effects

To enjoy the surround sound effects of this player or your amplifier (receiver), the following items must be set as described below for the audio connection you selected in page 21 to 23 (**B** through **D**). Each of these are the default settings and do not need to be adjusted when you first connect the player. Refer to page 56 for using the Setup Display.

Audio Connection (page 19 to 23)

A

No additional settings are needed.

B-1

C-1

Item	You select	Page
DOWNMIX	DOLBY SURROUND	58

- If the sound distorts even when the volume is turned down, set “AUDIO ATT” to “ON” (page 58).

B-2

C-2

D

Item	You select	Page
DOWNMIX	DOLBY SURROUND	58
DIGITAL OUT	ON	59

Playing Discs



Depending on the DVD or VIDEO CD, some operations may be different or restricted.

Refer to the operating instructions supplied with your disc.

POWER

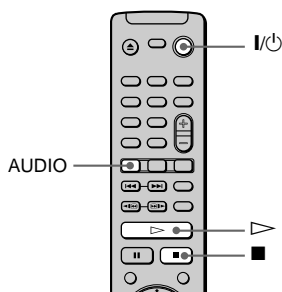
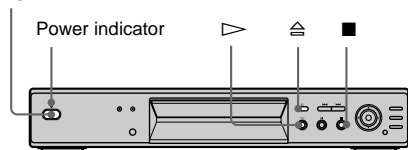

1 Turn on your TV.

2 Switch the input selector on the TV to the player.

When using an amplifier (receiver)

Turn on the amplifier (receiver) and select the appropriate channel.

3 Press **POWER** on the player.
The player enters standby mode and the power indicator lights up in red.

4 Press  on the player, and place a disc on the disc tray.

The player automatically turns on and the power indicator lights up in green.

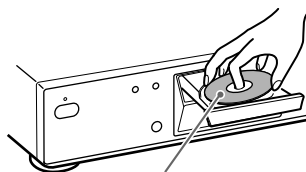

With the playback side facing down



5 Press .

The disc tray closes, and the player starts playback (continuous play).
Adjust the volume on the TV or the amplifier (receiver).



After following Step 5

Depending on the disc, a menu may appear on the TV screen. You can play the disc interactively by following the instructions on the menu. DVD (page 31), VIDEO CD (page 32).

To turn on the player

Press the **POWER** switch on the player. The player enters standby mode and the power indicator lights up in red. Press  on the remote. The player turns on and the power indicator lights up in green. In standby mode, the player also turns on by pressing  on the player or by pressing .

To turn off the player

Press  on the remote. The player enters standby mode and the power indicator lights up in red. To turn off the player completely, press **POWER** on the player. While playing a disc, do not turn off the player by pressing **POWER**. Doing so may cancel the menu settings. When you turn off the player, first press  to stop playback and then press  on the remote.

Notes on playing DTS sound tracks on a CD

- When playing DTS-encoded CDs, excessive noise will be heard from the analog stereo jacks. To avoid possible damage to the audio system, the consumer should take proper precautions when the analog stereo jacks of the player are connected to an amplification system. To enjoy DTS Digital Surround™ playback, an external 5.1-channel decoder system must be connected to the digital jacks of the player.
- Set the sound to “STEREO” using the AUDIO button when you play DTS sound tracks on a CD (page 42).
- Do not play DTS sound tracks without first connecting the player to an audio component having a built-in DTS decoder. The player outputs the DTS signal via the DIGITAL OUT (OPTICAL and COAXIAL) jacks even if “DTS” in “AUDIO SETUP” is set to “OFF” in the Setup Display (page 60), and may affect your ears or cause your speakers to be damaged.

Notes on playing DVDs with a DTS sound track

- DTS audio signals are output only through the DIGITAL OUT (OPTICAL and COAXIAL) jacks.
- If you connect the player to audio equipment without a DTS decoder, do not set “DTS” to “ON” in “AUDIO SETUP” (page 59). A loud noise may come out from the speakers, affecting your ears or causing the speakers to be damaged.
- When you play a DVD with DTS sound tracks, set “DTS” to “ON” in “AUDIO SETUP” (page 59).

Additional operations

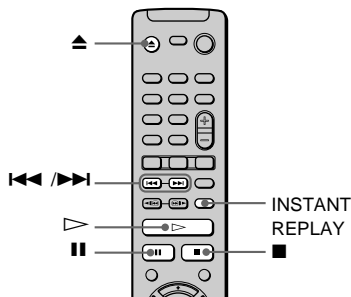

To	Operation
Stop	Press ■
Pause	Press ■■
Resume play after pause	Press ■■ or ▷
Go to the next chapter, track or scene in continuous play mode	Press ►►
Go back to the preceding chapter, track or scene in continuous play mode	Press ◀◀
Stop play and remove the disc	Press ▲
Replay a previous scene (DVD only)	Press INSTANT REPLAY

The Instant Replay function is useful when you want to review a scene or dialog that you missed.

Note

You may not be able to use the Instant Replay function with some scenes.

Resuming Playback from the Point Where You Stopped the Disc (Resume Play)



When you stop the disc, the player remembers the point where you pressed **■** and “RESUME” appears on the front panel display. As long as you do not open the disc tray, Resume Play works even if the player enters standby mode by pressing **⏻** on the remote.

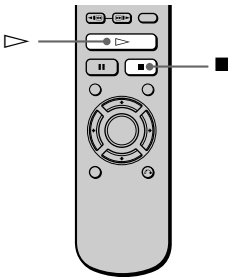

Notes

- Depending on where you stopped the disc, the player may not resume playback from exactly the same point.
- The point where you stopped playing is cleared when:
 - you turn the power off by pressing the POWER switch on the player.
 - you change the play mode.
 - you change the settings on the Setup Display.

1 While playing a disc, press **■** to stop playback.

“RESUME” appears on the front panel display and you can restart the disc from the point where you stopped the disc.

If “RESUME” does not appear, Resume Play is not available.

2 Press **▷**.

The player starts playback from the point where you stopped the disc in Step 1.

To play from the beginning of the disc, press **■** twice, then press **▷**.

Using the DVD's Menu

Some discs have a “title menu” or a “DVD menu.” On some DVDs, this may simply be called a “menu” or “title.”

Using the title menu

A DVD is divided into long sections of a picture or a music feature called “titles.” When you play a DVD which contains several titles, you can select the title you want using the title menu.

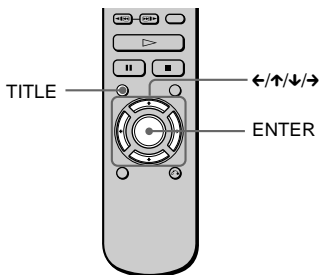

- 1** Press **TITLE**.
The title menu appears on the TV screen. The contents of the menu vary from disc to disc.

- 2** Press **←/↑/↓/→** to select the title you want to play.

- 3** Press **ENTER**.
The player starts playing the selected title.

 You can also display the title menu by pressing **TITLE** on the player.

Using the DVD menu

Some DVDs allow you to select the disc contents using a menu. When you play these DVDs, you can select items such as the language for the subtitles and the language for the sound using the DVD menu.

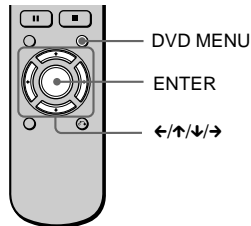

- 1** Press **DVD MENU**.
The DVD menu appears on the TV screen. The contents of the menu vary from disc to disc.

- 2** Press **←/↑/↓/→** to select the item you want to change.

- 3** To change other items, repeat Step 2.

- 4** Press **ENTER**.

 You can also display the DVD menu by pressing **DVD MENU** on the player.

Playing VIDEO CDs with PBC Functions (PBC Playback)



With PBC (Playback Control) functions, you can enjoy simple interactive operations, search functions, and other such operations. PBC playback allows you to play VIDEO CDs interactively by following the menu on the TV screen.

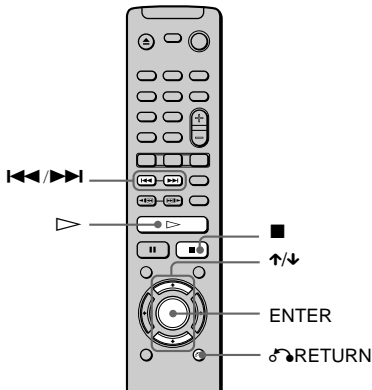

To play without using PBC, press while the player is stopped to select a track, then press or ENTER. "Play without PBC." appears on the TV screen and the player starts continuous play. You cannot play still pictures such as a menu. To return to PBC playback, press twice then press .

Note

Depending on the VIDEO CD, "Press ENTER" in Step 3 may appear as "Press SELECT" in the instructions supplied with the disc. In this case, press .

- 1** Start playing a VIDEO CD with PBC functions.
The menu for your selection appears.
- 2** Select the item number you want by pressing .
- 3** Press ENTER.
- 4** Follow the instructions in the menu for interactive operations.
Refer to the instructions supplied with the disc, as the operating procedure may differ according to the VIDEO CD.

To go back to the menu

Press RETURN.

Various Play Mode Functions (Program Play, Shuffle Play, Repeat Play, A-B Repeat Play)



You can set the following play modes:

- Program Play (page 33)
- Shuffle Play (page 35)
- Repeat Play (page 35)
- A- B Repeat Play (page 36)

Notes

- The play mode is cancelled when:
 - you open the disc tray.
 - the player enters standby mode by pressing **I/⏻** on the remote.
 - you turn the power off by pressing **POWER** on the player.
- If you are playing a VIDEO CD with PBC, you must first cancel PBC playback before you can set a play mode (except when you want to set A-B Repeat Play for moving pictures).

Creating your own program (Program Play)

You can play the contents of a disc in the order you want by arranging the order of the titles, chapters or tracks on the disc to create your own program. You can program up to 99 titles, chapters, and tracks.

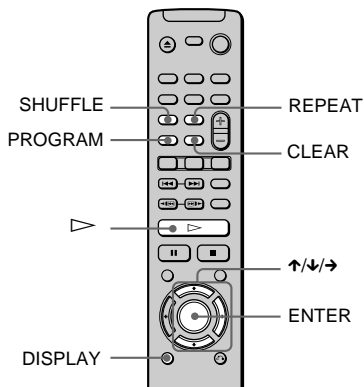

1 Press **DISPLAY** while the player is in stop mode.
The Control Menu is displayed.

2 Press **↑/↓** to select **PROGRAM** and press **ENTER**.

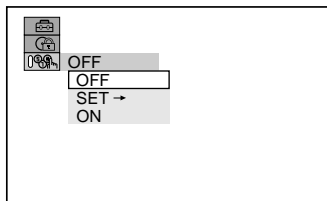

3 Press **↑/↓** to select "SET →" and press **ENTER**.

The display for programming appears.

Tracks or titles recorded on a disc

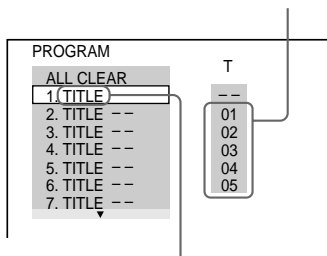

"TRACK" is displayed when you play a VIDEO CD or a CD.

4 Press **→**.

The cursor moves to the title or track (in this case, "01").

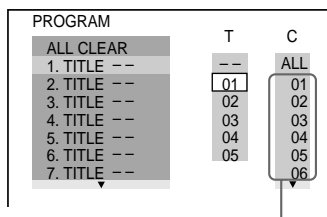

Chapter recorded on a disc

5 Select the title, chapter, or track you want to program.

■ When playing a DVD

For example, select chapter “03” of title “02”.

Press \uparrow/\downarrow to select “02” under “T,” then press ENTER.

PROGRAM	T	C
ALL CLEAR	--	ALL
1. TITLE --	01	01
2. TITLE --	02	02
3. TITLE --	03	03
4. TITLE --	04	04
5. TITLE --	05	05
6. TITLE --		06
7. TITLE --		

Next, press \uparrow/\downarrow to select “03” under “C,” then press ENTER.

PROGRAM	T
ALL CLEAR	--
1. TITLE 02-03	01
2. TITLE --	02
3. TITLE --	03
4. TITLE --	04
5. TITLE --	05
6. TITLE --	
7. TITLE --	

Selected title and chapter

■ When playing a VIDEO CD or CD

For example, select track “02.”

Press \uparrow/\downarrow to select “02” under “T,” then press ENTER.

PROGRAM	T	0:15:30
ALL CLEAR	--	
1. TRACK 02	01	
2. TRACK --	02	
3. TRACK --	03	
4. TRACK --	04	
5. TRACK --	05	
6. TRACK --		
7. TRACK --		

Total time of the programmed tracks

6 To program other titles, chapters, or tracks, repeat Steps 4 and 5.

The programmed titles, chapters, and tracks are displayed in the selected order.

7 Press \triangleright to start Program Play.

Program Play begins.

When the program ends, you can restart the same program again by pressing \triangleright .

To return to normal play

Press CLEAR, or select “OFF” in Step 3.

To play the same program again, select “ON” in Step 3 and press \triangleright .

To turn off the Control Menu

Press DISPLAY repeatedly until the Control Menu is turned off.

To change the program

1 In Step 4, select the program number of the title, chapter, or track you want to change using \uparrow/\downarrow , and press \rightarrow .

2 Follow Step 5 for new programming.

To cancel the programmed order

To cancel all the titles, chapters, or tracks in the programmed order, press \uparrow , and select “ALL CLEAR” in Step 4. To cancel the selected program, select the program using \uparrow/\downarrow in Step 4, then press CLEAR, or select “--” in Step 5, then press ENTER.

 You can do Repeat Play or Shuffle Play of the programmed titles, chapters, or tracks by pressing REPEAT or SHUFFLE during Program Play.

 You can select “PROGRAM” directly by pressing PROGRAM.

Note

The number of titles, chapters, or tracks displayed are the same number of titles, chapters, or tracks recorded on a disc.

Playing in random order (Shuffle Play)

You can have the player “shuffle” titles, chapters, or tracks and play them in a random order. Subsequent “shuffling” may produce a different playing order.

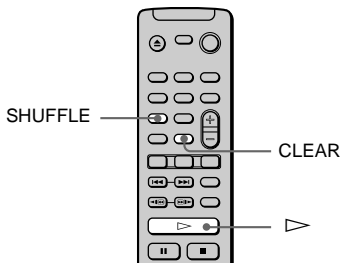

- 1 Press SHUFFLE during playback. The Control Bar is displayed.

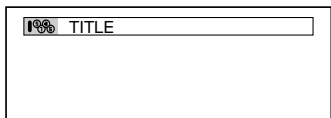

- 2 Press SHUFFLE repeatedly to select the item you want to set.

■ When playing a DVD (Program Play is set to OFF)

- TITLE: Shuffles titles and plays them in random order.
- CHAPTER: Shuffles chapters and plays them in random order.

■ When playing a VIDEO CD or CD (Program Play is set to OFF)

- TRACK: Shuffles tracks and plays them in random order.

■ When playing a VIDEO CD, CD, or DVD (Program Play is set to ON)

- ON: Shuffles titles or tracks selected in Program Play and plays them in random order.

To return to normal play

Press CLEAR or select “OFF” in Step 2.

You can set the player to “shuffle” in stop mode as well. After pressing SHUFFLE to select the item you want to set, press ▷. Shuffle Play starts.

Note

Up to 200 chapters in a disc can be played in random order when “CHAPTER” is selected.

Playing repeatedly (Repeat Play)

You can play all of the titles or tracks on a disc or a single title, chapter, or track repeatedly. You can use a combination of Shuffle or Program Play modes.

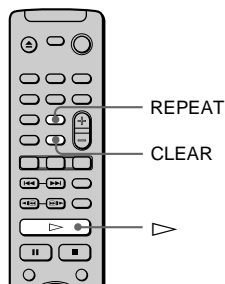

- 1 Press REPEAT during playback. The Control Bar appears.

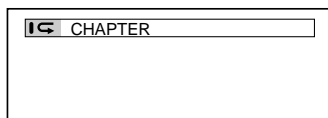

2 Press REPEAT repeatedly to select the item you want to set.

■ **When playing a DVD (Program Play and Shuffle Play are set to OFF)**

- **DISC:** Repeats all of the titles.
- **TITLE:** Repeats the current title on a disc.
- **CHAPTER:** Repeats the current chapter.

■ **When playing a VIDEO CD or CD (Program Play and Shuffle Play are set to OFF)**

- **DISC:** Repeats all of the tracks on a disc.
- **TRACK:** Repeats the current track.

■ **When Program Play or Shuffle Play is on**

- **ON:** Repeats Program Play or Shuffle Play.
-

To return to normal play

Press CLEAR or select “OFF” in Step 2.

💡 You can set the player to “repeat” in stop mode as well. After pressing REPEAT to select the item you want to set, press ▷. Repeat Play starts.

Repeating a specific portion (A-B Repeat Play)

You can play a specific portion of a title, chapter, or track repeatedly. (This function is useful when you want to memorize lyrics, etc.)

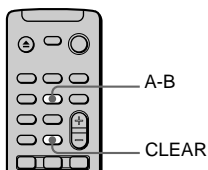

1 During playback, when you find the starting point (point A) of the portion to be played repeatedly, press A-B. The Control Bar appears. The starting point (point A) is set.

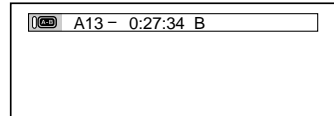

2 When you reach the ending point (point B), press A-B again.

The set points are displayed and the player starts repeating this specific portion.

“A-B” appears on the front panel display during A-B Repeat Play.

To return to normal play

Press CLEAR.

Notes

- You can set A-B Repeat Play for only one specific section.
- When you set A-B Repeat Play, the settings for Shuffle Play, Repeat Play, and Program Play are cancelled.

Searching for a Particular Point on a Disc (Scan, Slow-motion Play)



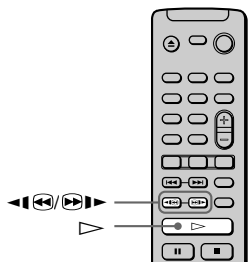

You can locate a particular point on a disc quickly by monitoring the picture or playing back slowly.



Note

Depending on the DVD/VIDEO CD, you may not be able to do some of the operations described.

Locating a point quickly by playing a disc in fast forward or fast reverse (Scan)





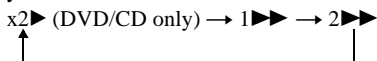

Press  or  while playing a disc. When you find the point you want, press  to return to normal speed. Each time you press  or  during scan the playback speed changes. Three speeds are available. With each press the indication changes as follows:

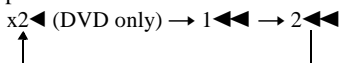
Playback direction







Opposite direction



The x2  / x2  playback speed is about twice the normal speed. The 2  / 2  playback speed is faster than 1  / 1 .

Watching frame by frame (Slow-motion play)

You can use this function only for DVDs or VIDEO CDs. Press  or  when the player is in the pause mode. To return to the normal speed, press .



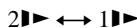

Each time you press  or  during Slow-motion play the playback speed changes. Two speeds are available. With each press the indication changes as follows:

Playback direction

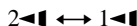

Opposite direction (DVD only)



The 2  / 2  playback speed is slower than 1  / 1 .

Searching for a Title/ Chapter/Track/Index/ Scene (Search mode)



You can search a DVD disc by title or chapter, and you can search a VIDEO CD or CD by track, index, or scene.

As titles and tracks are assigned unique numbers on the disc, you can select the desired one by entering its number. Or, you can search for a scene using the time code.

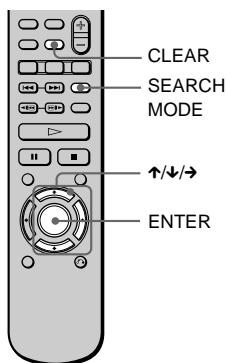

1 Press SEARCH MODE during playback.



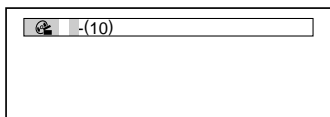

The Control Bar appears.

“--(**)” appears next to the icon on the Control Bar (** refers to a number). The number in parentheses indicates the total number of titles, tracks, scenes, etc. of the disc.





2 Press SEARCH MODE repeatedly to select the search method.

■ When playing a DVD

 (TITLE), , , or  (NUMBER INPUT)

Select “TIME/TEXT” to search for a starting point by inputting the time code.



■ When playing a VIDEO CD

 (TRACK) or  (INDEX)

■ When playing a VIDEO CD with PBC Playback

 (SCENE)

■ When playing a CD

 (TRACK) or  (INDEX)

3 Select the number of the title, track, scene, time code, etc., you want by pressing \uparrow/\downarrow to select the digit, followed by \rightarrow to move the cursor.

For example, to find the scene at 2 hours, 10 minutes, and 20 seconds after the beginning, select “TIME/TEXT” in Step 2 and enter “2:10:20.”

If you make a mistake

Cancel the number by pressing CLEAR, then select another number.

4 Press ENTER.

The player starts playback from the selected number.

 If you are playing a disc and it is necessary to enter a number, select “NUMBER INPUT” in Step 2.

Checking the Playing Time and Remaining Time on the Front Panel Display

DVD VIDEO CD CD

You can check information about the disc, such as the remaining time, total number of titles of a DVD, or tracks of a CD or VIDEO CD, using the front panel display (page 9).

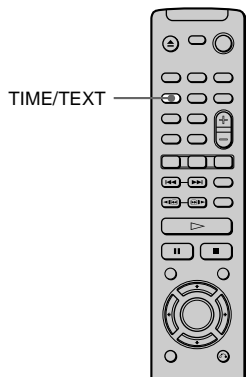

Press TIME/TEXT.

Each time you press TIME/TEXT while playing the disc, the display changes as shown in the following chart.

When playing a DVD

Playing time and number of the current title

TITLE	CHAP	HOUR	MIN	SEC
1	2	1	03	24



Remaining time of the current title

TITLE	CHAP	HOUR	MIN	SEC
1	2	-	15	36



Playing time and number of the current chapter

CHAP	HOUR	MIN	SEC
2	0	22	30



Remaining time of the current chapter

CHAP	HOUR	MIN	SEC
2	-	01	320



Text

SONY HITS/5

When playing a VIDEO CD (without PBC functions) or CD

Playing time and current track number

TRACK	INDEX	MIN	SEC
2	1	2	25



Remaining time of the current track

TRACK	INDEX	MIN	SEC
2	1	-	150



Playing time of the disc

MIN	SEC
32	12



Remaining time of the disc

MIN	SEC
-	2018



Text

SONY HITS/5

💡 When playing VIDEO CDs with PBC functions, the scene number and the playing time are displayed.

 The playing time and remaining time of the current chapter, title, track, scene, or disc will also appear on your TV screen. See the following section “Checking the Playing Time and Remaining Time” for instructions on how to read this information.

Note

Depending on the type of disc being played and the playing mode, the above mentioned disc information may not be displayed.

Checking the Playing Time and Remaining Time

You can check the playing time and remaining time of the current title, chapter, or track, and the total playing time or remaining time of the disc. Also, you can check the DVD/CD text recorded on the disc.

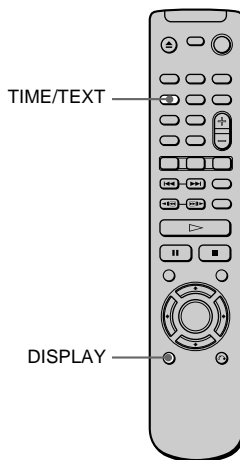

1 Press DISPLAY once during playback.

The Status Bar is displayed.

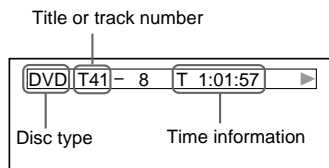

2 Press TIME/TEXT repeatedly to change the time information.

The display and the kinds of time that you can change depend on the disc you are playing.

■ When playing a DVD

- T **:**:**
Playing time of the current title
- T- **:**:**
Remaining time of the current title
- C **:**:**
Playing time of the current chapter
- C- **:**:**
Remaining time of the current chapter

■ When playing a VIDEO CD (with PBC functions)

- **:**:**
Playing time of the current scene

■ When playing a VIDEO CD (without PBC functions) or CD

- T **:**:**
Playing time of the current track
- T- **:**:**
Remaining time of the current track
- D **:**:**
Playing time of the current disc
- D- **:**:**
Remaining time of the current disc

💡 If the DVD/CD text does not fit on a single line, you can see the entire text by watching it scroll across the front panel display.

💡 You can select the time and text directly by pressing TIME/TEXT.

Notes

- Only letters of the alphabet can be displayed.
- This player can only display the first level of DVD/CD text, such as the disc's name or title.

To turn off the Status Bar

Press DISPLAY repeatedly until the Status Bar is turned off.

Checking the DVD/CD text

Press TIME/TEXT repeatedly in Step 2 to display the text recorded on the DVD/CD.

The DVD/
CD text

BRAHMS SYMPHONY

Changing the Sound



If the DVD is recorded with multilingual tracks, you can select the language you want while playing the DVD.

If the DVD is recorded in multiple audio formats (PCM, Dolby Digital or DTS), you can select the audio format you want while playing the DVD.

With stereo CDs or VIDEO CDs, you can select the sound from the right or left channel and listen to the sound of the selected channel through both the right and left speakers. (In this case, the sound loses its stereo effect.) For example, when playing a disc containing a song with the vocals on the right channel and the instruments on the left channel, you can select the left channel and hear the instruments from both speakers.

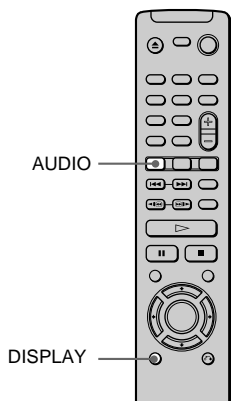

1 Press AUDIO during playback.

The Control Bar is displayed. The number in parentheses indicates the total number of available audio signals.

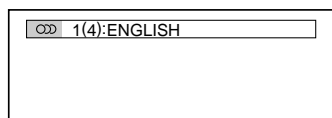

2 Press AUDIO repeatedly to select the desired audio signal.

■ When playing a DVD

Depending on the DVD, the choice of language varies.

When 4 digits are displayed, they represent the language code. Refer to the language code list on page 67 to see which language the code represents. When the same language is displayed two or more times, the DVD is recorded in multiple audio formats.

■ When playing a VIDEO CD or CD

The default setting is underlined.

- STEREO: The standard stereo sound
- 1/L: The sound of the left channel (monaural)
- 2/R: The sound of the right channel (monaural)

Notes

- For discs not in multiple audio format, you cannot change the sound.
- While playing a DVD, the sound may change automatically.

Checking the audio signal format



If you press DISPLAY twice during playback, the format of the current audio signal (Dolby Digital, DTS, PCM, etc.) appears as shown below.

Example

- Dolby Digital 5.1 ch

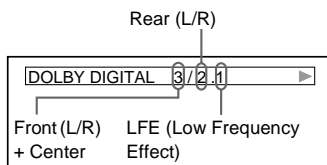

- Dolby Digital 3 ch

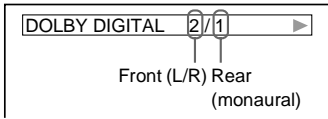

- PCM (Stereo)

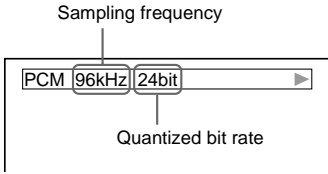

About audio signals

Audio signals recorded in a disc contain the sound elements (channels) shown below. Each channel is output from a separate speaker.

- Front (L)
- Front (R)
- Center
- Rear (L)
- Rear (R)
- Rear (Monaural): This signal can be either the Dolby Surround Sound processed signals or the Dolby Digital sound's monaural rear audio signals.
- LFE (Low Frequency Effect) signal

Note

If "DTS" is set to "OFF" in "AUDIO SETUP," the DTS track selection option will not appear on the screen even if the disc contains DTS tracks (page 59).

TV Virtual Surround Sound Settings (TVS)



When you connect a stereo TV or 2 front speakers, TV Virtual Surround lets you enjoy surround sound effects by using sound imaging to create virtual rear speakers from the sound of the front speakers (L: left, R: right) without using actual rear speakers. This function is designed to work with the LINE OUT L/R (AUDIO) 1/2 jacks.

Note that if you select one of the TVS settings while playing a DVD, the player does not output Dolby Digital signals from the DIGITAL OUT (COAXIAL and OPTICAL) jacks (when you set "DOLBY DIGITAL" in "AUDIO SETUP" to "D-PCM") (page 59).

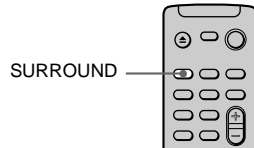

- 1 Press SURROUND during playback.

The Control Bar is displayed.

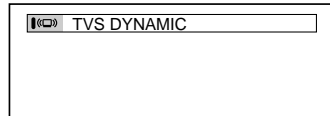

- 2 Press SURROUND repeatedly to select one of the TVS (TV Virtual Surround) sounds.

Refer to the explanations given for each item.

- TVS DYNAMIC
- TVS WIDE
- TVS NIGHT
- TVS STANDARD

To reset the TVS setting

In Step 2, select “OFF.”

TVS (TV Virtual Surround) DYNAMIC

Uses sound imaging to create virtual rear speakers from the sound of the front speakers (L/R) without using actual rear speakers (shown below). The sound imaging effect is distinct and clearly reproduces each aural element of the audio track.

This mode is effective when the distance between the front L and R speakers is short, such as with built-in speakers on a stereo TV.

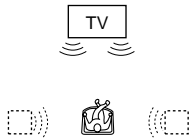

TVS (TV Virtual Surround) WIDE

Uses sound imaging to create virtual rear speakers from the sound of the front speakers (L/R) without using actual rear speakers. The virtual speakers are reproduced as shown in the illustration below. This gives the sound an expanded effect that fills the area surrounding the listener.

This mode is effective when the distance between the front L and R speakers is short, such as with built-in speakers on a stereo TV.

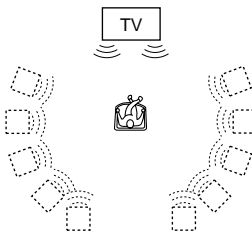

TVS (TV Virtual Surround) NIGHT

The large sounds, such as explosions, are suppressed, but the quieter sounds are unaffected. This feature is useful when you don't want to disturb other people but still want to hear the dialog and enjoy the surround sound effects of TVS WIDE.

TVS (TV Virtual Surround) STANDARD

Uses sound imaging to create virtual rear speakers from the sound of the front speakers (L/R) without using actual rear speakers. The virtual speakers are reproduced as shown in the illustration below. Use this setting when you want to use TVS with 2 separate speakers and retain the sound quality.

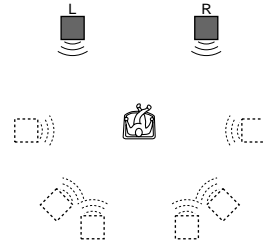

L: Left front speaker
R: Right front speaker
□: Virtual speakers

 You can also change the TVS setting by pressing SURROUND on the player. If you select any TVS setting other than “OFF,” the indicator on the player lights up.

Notes

- When you select an effect, the sound cuts off for a moment.
- When the playing signal does not contain a signal for the rear speakers (page 43), the surround effects may be difficult to hear.
- When you select one of the TV modes, turn off the surround setting of connected TV or amplifier (receiver).
- Make sure that your listening position is between and at an equal distance from your speakers, and that the speakers are located in similar surroundings. Otherwise, the TVS effect may be hard to discern.
- TVS NIGHT only works with Dolby Digital discs. However, not all discs will respond to the TVS NIGHT function in the same way.
- If you use the DIGITAL OUT (COAXIAL and OPTICAL) jacks and set “DOLBY DIGITAL” to “DOLBY DIGITAL” in “AUDIO SETUP,” sound will come from your speakers but it will not have the TVS effect.

Changing the Angles

If various angles (multi-angles) for a scene are recorded on the DVD, “ANGLE” appears in the front panel display. This means that you can change the viewing angle.

For example, while playing a scene of a train in motion, you can display the view from either the front of the train, the left window of the train, or from the right window without having the train’s movement interrupted.

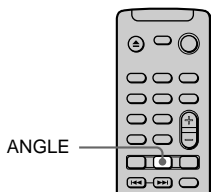

1 Press ANGLE during playback.

The Control Bar is displayed. The number in parentheses indicates the total number of available angles.

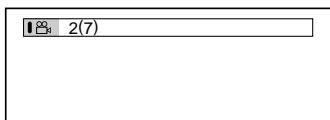

2 Press ANGLE repeatedly to select the angle number.

The scene changes to the selected angle.

Note

Depending on the DVD, you may not be able to change the angles even if multi-angles are recorded on the DVD.

Displaying the Subtitles

If subtitles are recorded on the disc, you can turn the subtitles on and off whenever you want while playing. If multilingual subtitles are recorded on the disc, you can change the subtitle language while playing, and turn it on or off whenever you want. For example, you can select the language you want to practice and turn the subtitles on for better understanding.

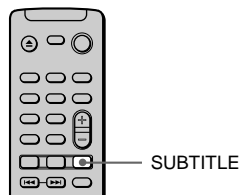

1 Press SUBTITLE during playback.

The Control Bar is displayed. The number in parentheses indicates the total number of available subtitles.

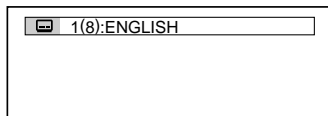

2 Press SUBTITLE repeatedly to select the language.

Depending on the DVD, the choice of language varies.

When 4 digits are displayed, they indicate the language code. Refer to the language code list on page 67 to see which language the code represents.

To turn off the subtitles

Select “OFF” in Step 2.

Note

Depending on the DVD, you may not be able to change the subtitles even if multilingual subtitles are recorded on it.

Adjusting the Picture Quality (BNR)

The Block Noise Reduction (BNR) function adjusts the picture quality by reducing the “block noise” or mosaic like patterns that appear on your TV screen.

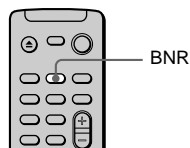

-
- 1** Press BNR during playback.
The Control Bar is displayed.

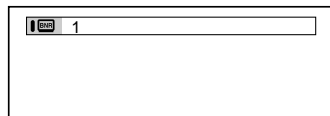

- 2** Press BNR repeatedly to select a level.
As the value increases, the mosaic like patterns on your TV screen will decrease.
 - 1: reduces the “block noise.”
 - 2: reduces the “block noise” more than 1.
 - 3: reduces the “block noise” more than 2.
-

To reset the BNR setting

Select “OFF” in Step 2.

 You can also change the BNR value by pressing BNR on the player. If you select any setting other than “OFF,” the indicator on the player lights up.

Notes

- If the outlines of the images on your screen should become blurred, set BNR to “OFF.”
- Depending on the disc or the scene being played, the BNR effect may be hard to discern.

Locking DISCS (Custom Parental Control, Parental Control)

You can set two kinds of playback restrictions for the desired disc.

- Custom Parental Control

You can set the playback restrictions so that the player will not play inappropriate discs.

- Parental Control

Playback of some DVDs can be limited according to a predetermined level such as the age of the users.

The same password is used for both Parental Control and Custom Parental Control.

Custom Parental Control



You can set the same Custom Parental Control password for up to 50 discs. When you set the fifty-first-disc, the first disc is cancelled.

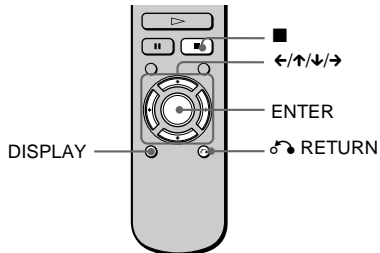

1 Insert the disc you want to lock.
If the disc is playing, press ■ to stop playback.

2 Press DISPLAY while the player is in stop mode.
The Control Menu is displayed.

3 Press ↑/↓ to select (CUSTOM PARENTAL CONTROL), then press ENTER.
“CUSTOM PARENTAL CONTROL” is selected.

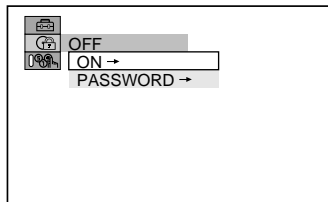

4 Press ↑/↓ to select “ON →,” then press ENTER.

■ If you have not entered a password

The display for registering a new password appears.

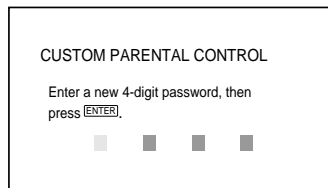

Enter a 4-digit password by pressing ↑/↓ to select the digit, followed by → to move the cursor. Then press ENTER.

The display for confirming the password appears.

■ When you have already registered a password

The display for entering the password appears.

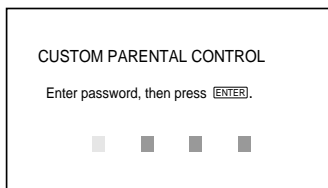

-
- 5** Enter or re-enter your 4-digit password by pressing \uparrow/\downarrow to select the digit, followed by \rightarrow to move the cursor. Then press ENTER.

“Custom parental control is set.” appears and then the screen returns to the Control Menu display.

If you make a mistake entering your password

Press \leftarrow before you press ENTER and input the correct number.

If you make a mistake

Press \curvearrowright RETURN and repeat from Step 3.

To turn off the Control Menu

Press \curvearrowright RETURN and then DISPLAY repeatedly until the Control Menu is turned off.

To turn off the Custom Parental Control function

- 1** In Step 4, select “OFF \rightarrow ,” then press ENTER.
- 2** Enter your 4-digit password using \uparrow/\downarrow to select the digit, followed by \rightarrow to move the cursor. Then press ENTER.

To change the password

- 1** In Step 4, press \uparrow/\downarrow to select “PASSWORD \rightarrow ,” then press ENTER. The display for entering the password appears.
- 2** Enter your 4-digit password using \uparrow/\downarrow to select the digit, followed by \rightarrow to move the cursor. Then press ENTER.
- 3** Enter a new 4-digit password using \uparrow/\downarrow to select the digit, followed by \rightarrow to move the cursor. Then press ENTER.
- 4** To confirm your password, re-enter it using \uparrow/\downarrow to select the digit, followed by \rightarrow to move the cursor. Then press ENTER.

Playing the disc for which Custom Parental Control is set

- 1** Insert the disc for which Custom Parental Control is set.

The CUSTOM PARENTAL CONTROL display appears.

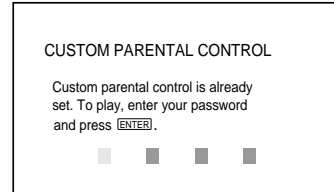

- 2** Enter your 4-digit password using \uparrow/\downarrow to select the digit, followed by \rightarrow to move the cursor. Then press ENTER.

The player is ready for playback.

If you forget your password, enter the 6-digit number “199703” when the CUSTOM PARENTAL CONTROL display asks you for your password, then press ENTER. (Press \rightarrow after the 4th digit to allow the entire 6-digit number to be entered.) The display will ask you to enter a new 4-digit password.

Limiting playback by children (Parental Control) DVD

Playback of some DVDs can be limited according to a predetermined level such as the age of the users. The Parental Control function allows you to set a playback limitation level.

A scene that is limited is not played, or it is replaced by a different scene.

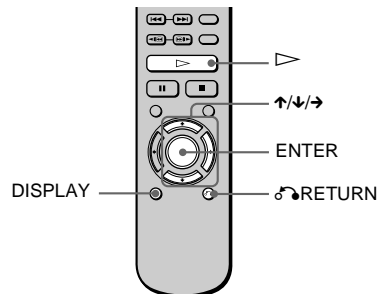

1 Press **DISPLAY** while the player is in stop mode.
The Control Menu is displayed.

2 Press **↑/↓** to select **SETUP** (SETUP), then press **ENTER**.

3 Press **↑/↓** to select "CUSTOM," then press **ENTER**.
The Setup Display appears.

4 Press **↑/↓** to select "CUSTOM SETUP," then press **ENTER**.
"CUSTOM SETUP" is displayed.

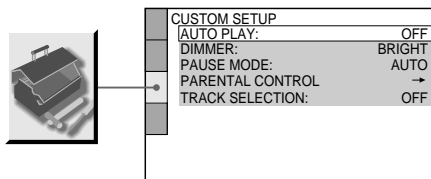

5 Press **↑/↓** to select "PARENTAL CONTROL →," then press **ENTER**.

■ If you have not entered a password

The display for registering a new password appears.

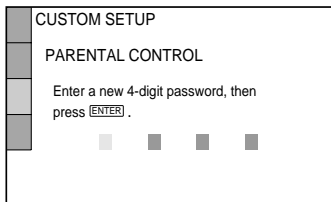

Enter a 4-digit password using by pressing **↑/↓** to select the digit, followed by **→** to move the cursor. Then press **ENTER**.

The display for confirming the password appears.

■ When you have already registered a password

The display for entering the password appears.

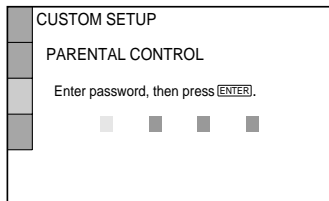

6 Enter or re-enter your password using **↑/↓** to select the digit, followed by **→** to move the cursor. Then press **ENTER**.

The display for setting the playback limitation level and changing the password appears.

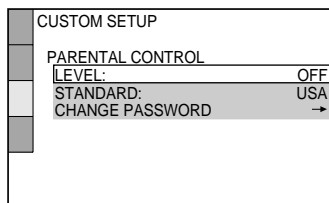

7 Press **↑/↓** to select "STANDARD," then press **ENTER**.

The selection items for "STANDARD" are displayed.

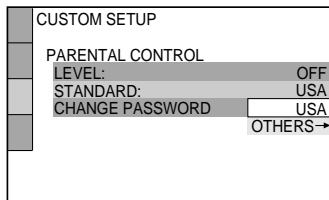

-
- 8** Press **↑/↓** to select a geographic area as the playback limitation level, then press **ENTER**.

The area is selected.

When you select “OTHERS →,” select and enter the standard code in the table on page 51 using **↑/↓**.

- 9** Press **ENTER**.

The selection items for “LEVEL” are displayed.

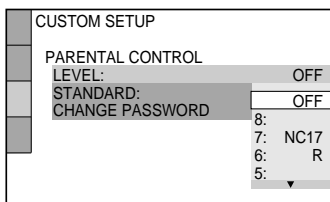

-
- 10** Select the level you want using **↑/↓**, then press **ENTER**.

Parental Control setting is complete.

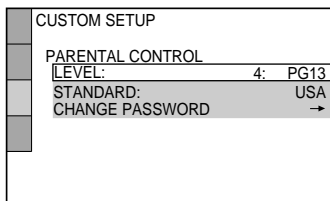

The lower the value, the more strict the limitation.

If you make a mistake

Press **↶** RETURN to go back to the previous screen.

To turn off the Control Menu

Press **DISPLAY** repeatedly until the Control Menu is turned off.

To turn off the Parental Control function and play the DVD after entering your password

Set, “LEVEL” to “OFF” in Step 10.

To change the password

- 1** In Step 7, select “CHANGE PASSWORD →” using **↓**, then press **ENTER**.

The display for entering the password appears.

- 2** Follow Step 6 to enter a new password.

Playing the disc for which Parental Control is set

- 1 Insert the disc and press \blacktriangleright .
The Control Bar appears.

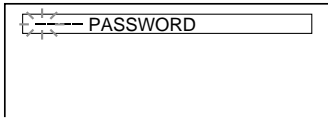

- 2 Enter your 4-digit password using \uparrow/\downarrow to select the digit, followed by \rightarrow to move the cursor. Then press ENTER.
The player starts playback.

 If you forget your password, remove the disc and repeat Step 1 to 5 of “Limiting playback by children.” When you are asked to enter your password, enter “199703,” then press ENTER. (Press \rightarrow after the 4th digit to allow the entire 6 digit number to be entered.) The display will ask you to enter a new 4-digit password. After you enter a new 4-digit password in Step 6, replace the disc in the player and press \blacktriangleright . When the Control Bar appears, enter your new password.

Note

When you play DVDs which do not have the Parental Control function, playback cannot be limited on this player.

Area Code

Standard	Code number	Standard	Code number
Argentina	2044	Korea	2304
Australia	2047	Malaysia	2363
Austria	2046	Mexico	2362
Belgium	2057	Netherlands	2376
Brazil	2070	New Zealand	2390
Canada	2079	Norway	2379
Chile	2090	Pakistan	2427
China	2092	Philippines	2424
Denmark	2115	Portugal	2436
Finland	2165	Russia	2489
France	2174	Singapore	2501
Germany	2109	Spain	2149
Hong Kong`	2219	Sweden	2499
India	2248	Switzerland	2086
Indonesia	2238	Taiwan	2543
Italy	2254	Thailand	2528
Japan	2276	United Kingdom	2184

Operation Sound Effects

(Sound Feedback)

The player beeps when the following operations are performed.

The default setting of the Sound Feedback function is set to off.

Operation	Operation sound
Power is turned on	One beep
Power is turned off	Two beeps
▷ is pressed	One beep
is pressed	Two beeps
Playback is stopped	One long beep
Operation is not possible	Three beeps

To set Sound Feedback

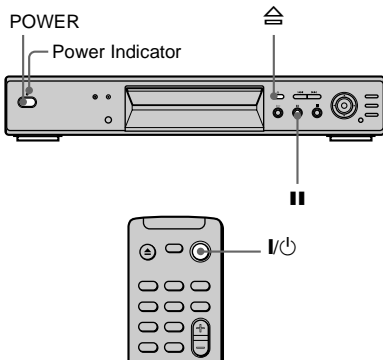

-
- 1** Press **POWER** on the player, then press **I/⏻** on the remote.

The power indicator lights up in green. When there is a disc in the player, press **⏻** and remove the disc. Then press **⏻** again to close the disc tray.

-
- 2** Press and hold **||** on the player for more than two seconds.

You will hear one beep and the Sound Feedback function is turned on.

To turn off the Sound Feedback function

When there is no disc in the player, press and hold **||** on the player for more than two seconds. You will hear two beeps and the Sound Feedback function is turned off.

Controlling Your TV with the Supplied Remote

By adjusting the remote signal, you can control your TV with the supplied remote.

Controlling TVs with the remote

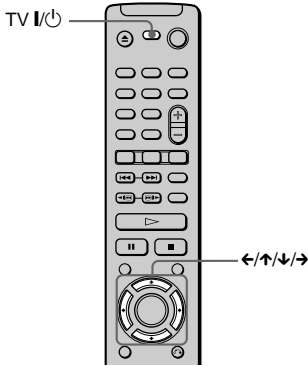

- 1 Hold down TV I/⏻, and enter your TV's manufacturer's code (see the table below) using ←/↑/↓/→.
- 2 Release TV I/⏻.

Manufacturer's codes of controllable TVs.

Manufacture	Press ←/↑/↓/→ to input code
Sony (default)	↑ ↑
General Electric	↑ ←
JVC	↓ ↑
Panasonic	→ →
Philips	↑ →
Quasar	→ ↓
RCA	↑ ←
Samsung	↓ →
Sanyo	↑ ↓
Sears	→ ← or ↑ ←
Sharp	→ ↓
Toshiba	→ ←
Zenith	→ ↑

Notes

- If you enter a new manufacturer's code, the code previously entered will be erased.
- When you replace the batteries of the remote, the code you have set may be reset to the default setting. Set the appropriate code again.

Controlling the TV

By adjusting remote signal, you can control the sound level, input source, and power switch of your TV with the supplied remote.

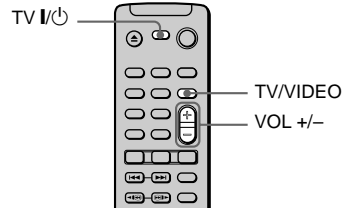

You can control your TV using the buttons below.

By pressing	You can
TV I/⏻	Turn the TV on or off
VOL (volume) +/-	Adjust the volume of the TV
TV/VIDEO	Switch the TV's input source between the TV and other input sources

Note

Depending on the units being connected, you may not be able to control your TV or to use some of the buttons.

Using the Setup Display



By using the Setup Display, you can make various adjustments to items such as picture and sound. You can also set a language for the subtitles and the Setup Display, among other things. If you press SETUP on the remote, you can directly display the settings in "SETUP" on your screen. For details on each Setup Display item, see page 55. For an overall list of Setup Display items, see page 68.

How to use the Setup Display

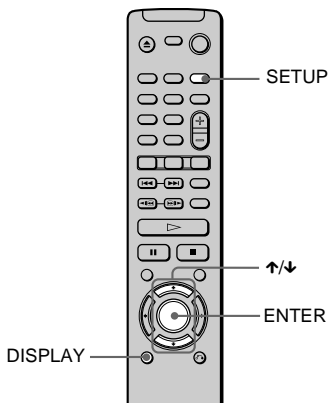

- 1 Press DISPLAY on the remote when the player is in stop mode. The Control Menu appears

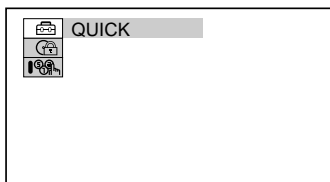

- 2 Press \uparrow/\downarrow to select (SETUP) and press ENTER.

- 3 Press \uparrow/\downarrow to select "CUSTOM" and press ENTER. The Setup Display appears.

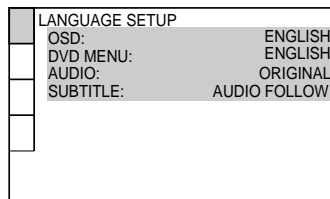

- 4 Press \uparrow/\downarrow to select the setup item from the displayed list: "LANGUAGE SETUP," "SCREEN SETUP," "CUSTOM SETUP," or "AUDIO SETUP." Then press ENTER. The selected setup item appears. Example: SCREEN SETUP

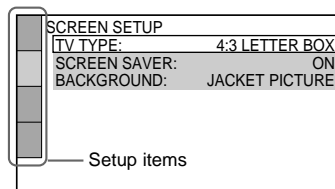

- 5 Select an item using \uparrow/\downarrow , then press ENTER. The options for the selected item appear. Example: TV TYPE

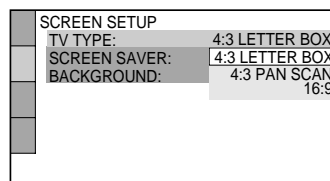



- 6 Select a setting using \uparrow/\downarrow , then press ENTER. The setting is selected and setup is complete. Example: 16:9

SCREEN SETUP	
TV TYPE:	16:9
SCREEN SAVER:	ON
BACKGROUND:	JACKET PICTURE

To turn off the Setup Display

Press DISPLAY repeatedly until the Setup Display is turned off.

 If you select “QUICK” in Step 3, you will enter Quick Setup mode (page 24). Follow from Step 5 of the Quick Setup explanation to make basic adjustments.

 If you select “RESET” in Step 3, you can reset all of the “SETUP” settings on page 68 to 69 (except for “PARENTAL CONTROL”) to the default settings. After you select “RESET” and press ENTER, select “YES” and press ENTER to reset the settings (it takes a few seconds to complete), or select “NO” and press ENTER to return to the Control Menu. Do not press POWER or  when resetting the player.

Setting the Display or Sound Track Language

(LANGUAGE SETUP)



“LANGUAGE SETUP” allows you to set various languages for the on-screen display or sound track.

Select “LANGUAGE SETUP” in the Setup Display. For details on using the display, see “Using the Setup Display” (page 54).



LANGUAGE SETUP	
OSD:	ENGLISH
DVD MENU:	ENGLISH
AUDIO:	ORIGINAL
SUBTITLE:	AUDIO FOLLOW

■ OSD (On-Screen Display)

Switches the display language on the screen. Selects the language from the displayed list.

■ DVD MENU (DVD only)

You can select the desired language for the DVD menu.

■ AUDIO (DVD only)

Switches the language of the sound track. Selects the language from the displayed list. When you select “ORIGINAL,” the language given priority in the disc is selected.

■ SUBTITLE (DVD only)

Switches the language of the subtitles recorded on the DVD. Select the language from the displayed list. When you select “AUDIO FOLLOW,” the language for the subtitles changes according to the language you selected for the sound track.

 If you select “OTHERS →” in “DVD MENU,” “SUBTITLE,” and “AUDIO,” select and enter the language code from the list using \uparrow/\downarrow to select the digit, followed by \rightarrow to move the cursor (page 67). After you have made a selection, the language code (4 digits) is displayed the next time you select “OTHERS →.”

Note

When you select a language that is not recorded on the DVD, one of the recorded languages will be automatically selected (except for the “OSD”).

Settings for the Display

(SCREEN SETUP)   

Choose settings according to the TV to be connected.

Select “SCREEN SETUP” in the Setup Display. For details on using the display, see “Using the Setup Display” (page 54). The default settings are underlined.

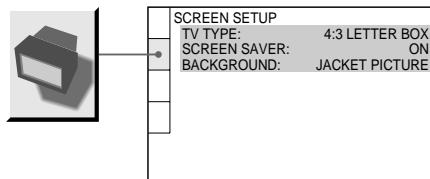

■ **TV TYPE (DVD only)**

Selects the aspect ratio of the connected TV (4:3 standard or wide).

<u>4:3 LETTER BOX</u>	Select this when you connect a 4:3 screen TV. Displays a wide picture with bands on the upper and lower portions of the screen.
4:3 PAN SCAN	Select this when you connect a 4:3 screen TV. Automatically displays the wide picture on the entire screen and cuts off the portions that do not fit.
16:9	Select this when you connect a wide-screen TV or a TV with a wide mode function.

4:3 LETTER BOX



4:3 PAN SCAN



16:9

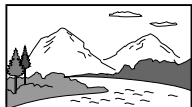

Note

Depending on the DVD, “4:3 LETTER BOX” may be selected automatically instead of “4:3 PAN SCAN” or vice versa.

■ SCREEN SAVER

Turns on and off the screen saver so that the screen saver image appears when you leave the player in pause or stop mode for 15 minutes, or when you play back a CD for more than 15 minutes. The screen saver will help prevent your display device from becoming damaged (ghosting). Press \blacktriangleright to turn off the screen saver.

<u>ON</u>	Turns on the screen saver.
OFF	Turns off the screen saver.

■ BACKGROUND

Selects the background color or picture on the TV screen in stop mode or while playing a CD.

<u>JACKET PICTURE</u>	The jacket picture (still picture) appears in the background, but only when the jacket picture is already recorded on the disc (CD-EXTRA etc.). If the disc does not contain a jacket picture, the “GRAPHICS” picture appears.
GRAPHICS	A preset picture stored in the player appears in the background.
BLUE	The background color is blue.
BLACK	The background color is black.

Custom Settings (CUSTOM

SETUP) **DVD** **VIDEO CD** **CD**

Allows setting up Parental Control and other settings.

Select “CUSTOM SETUP” in the Setup Display. For details on using the display, see “Using the Setup Display” (page 54). The default settings are underlined.

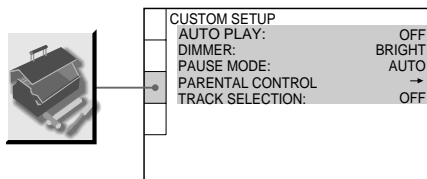

■ AUTO PLAY

Selects the Auto Play setting when you turn on the player.

<u>OFF</u>	Does not use “TIMER,” “DEMO1,” or “DEMO2” to start playback.
TIMER	Starts playing when the player is turned on. The player can be played at any time when connected to a timer (not supplied). Set the timer when the player is in standby mode (the power indicator lights up in red).
DEMO1	Starts playing the first demonstration automatically.
DEMO2	Starts playing the second demonstration automatically.

■ DIMMER

Adjusts the lighting of the front panel display.

<u>BRIGHT</u>	Makes the front panel display bright.
DARK	Makes the front panel display dark.
OFF	Turns off the lighting of the front panel display.

continued

■ PAUSE MODE (DVD only)

Selects the picture in pause mode.

<u>AUTO</u>	The picture, including subjects that move dynamically, is output with no jitter. Normally select this position.
FRAME	The picture, including subjects that do not move dynamically, is output in high resolution.

■ PARENTAL CONTROL → (DVD only)

Sets a password and playback limitation level for DVDs with playback limitation for children. For details, see “Limiting playback by children (Parental Control)” (page 47).

■ TRACK SELECTION (DVD only)

Gives the sound track which contains the highest number of channels priority when you play a DVD on which multiple audio formats (PCM, DTS or Dolby Digital format) are recorded.

<u>OFF</u>	No priority given.
AUTO	Priority given.

Notes

- When you set the item to “AUTO,” the language may change. The “TRACK SELECTION” setting has higher priority than the “AUDIO” settings in “LANGUAGE SETUP” (page 55).
- If you set “DTS” to “OFF” (page 59) set the DTS sound track is not played even if you set “TRACK SELECTION” to “AUTO.”
- If PCM, DTS and Dolby Digital sound tracks have the same number of channels, the player selects PCM, DTS and Dolby Digital sound tracks in this order.
- Depending on the DVD, the audio channel with priority may be predetermined. In this case, you cannot give priority to the DTS, or Dolby Digital, format by selecting “AUTO.”

Settings for the Sound (AUDIO SETUP)

“AUDIO SETUP” allows you to set the sound according to the playback and connection conditions.

Select “AUDIO SETUP” in the Setup Display. For details on using the display, see “Using the Setup Display” (page 54). The default settings are underlined.

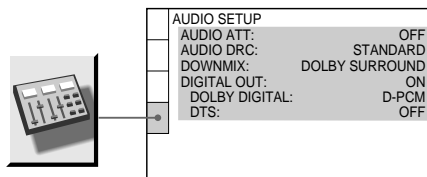

■ AUDIO ATT (attenuation)

If the playback sound is distorted, set this item to “ON.” The player reduces the audio output level.

This function affects the output of the following jacks:

— LINE OUT L/R (AUDIO) 1/2 jacks

<u>OFF</u>	Turns off the audio attenuation. Normally, select this position.
ON	Reduces the audio output level so that no sound distortion occurs. Select this when the playback sound from the speakers is distorted.

■ AUDIO DRC (Dynamic Range Control) (DVD only)

Makes the sound clear when the volume is turned down when playing a DVD that has the AUDIO DRC function. This affects the output from the following jacks:

— LINE OUT L/R (AUDIO) 1/2 jacks

— DIGITAL OUT (OPTICAL and COAXIAL) jacks only when “DOLBY DIGITAL” is set to “D-PCM” in “DIGITAL OUT” (page 59).

STANDARD	Normally, select this position
TV MODE	Makes the low sounds clear even if you turn the volume down. It is especially recommended when you listen to the sound using the speakers of the TV.
WIDE RANGE	Gives you the feeling of being at a live performance. When you use high quality speakers, it is even more effective.

■ DOWNMIX (DVD only)

Switches the mixing down methods when you play a DVD on which rear signal components such as LS, RS, or S are recorded in Dolby Digital format. For details on the rear signal components, see “Changing the Sound” (page 42). This function affects the output of the following jacks:

- LINE OUT L/R (AUDIO) 1/2 jacks
- DIGITAL OUT (OPTICAL and COAXIAL) jacks when “DOLBY DIGITAL” is set to “D-PCM” in “DIGITAL OUT” (page 59).

DOLBY SURROUND	Select this when the player is connected to an audio component that conforms to Dolby Surround (Pro Logic). The output signals which reproduce the Dolby Surround effect are downmixed to 2 channels.
NORMAL	Select this when the player is connected to an audio component that does not conform to Dolby Surround (Pro Logic). All of the output signals are downmixed to 2 channels without the Dolby Surround (Pro Logic) effect.

■ DIGITAL OUT

Selects if audio signals are output via the DIGITAL OUT (OPTICAL and COAXIAL) jacks.

ON	Normally, select this position. When you select “ON,” set “DOLBY DIGITAL,” and “DTS.” For details on setting these items, see “Setting the digital output signal.”
OFF	The player does not output the audio signals via the DIGITAL OUT (OPTICAL and COAXIAL) jacks. The influence of the digital circuit upon the analog circuit is minimal.

Setting the digital output signal

Switches the method of outputting audio signals when you connect the following component using a digital cord via the DIGITAL OUT (OPTICAL or COAXIAL) jacks.

- Amplifier (receiver) with digital input jack
- Amplifier (receiver) with a built-in DTS, or DOLBY DIGITAL decoder
- MD or DAT deck

For connection details, see page 19. Select “DOLBY DIGITAL,” and “DTS” after setting “DIGITAL OUT” to “ON.”

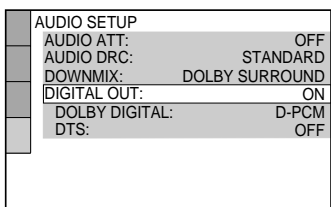

■ DOLBY DIGITAL

Selects the Dolby Digital signals output via the DIGITAL OUT (OPTICAL and COAXIAL) jacks.

<u>D-PCM</u>	Select this when the player is connected to an audio component lacking a built-in Dolby Digital decoder. You can select whether the signals conform to Dolby Surround (Pro Logic) or not by making adjustments to the “DOWNMIX” item in “AUDIO SETUP” (page 58).
DOLBY DIGITAL	Select this when the player is connected to an audio component with a built-in Dolby Digital decoder. If the player is connected to an audio component lacking a built-in Dolby Digital decoder, do not set this. Otherwise, when you play the Dolby Digital sound track, a loud noise (or no sound) will come out from the speakers, affecting your ears or causing the speakers to be damaged.

Note

If you select one of the TVS settings while playing a DVD, the player does not output Dolby Digital signals from the DIGITAL OUT (COAXIAL and OPTICAL) jacks (when you set “DOLBY DIGITAL” in “AUDIO SETUP” to “D-PCM”).

■ DTS

Selects if DTS signals are output via the DIGITAL OUT (OPTICAL and COAXIAL) jacks.

<u>OFF</u>	Select this when the player is connected to an audio component lacking a built-in DTS decoder. Note, however, that the DTS signals contained in a CD are output even if “OFF” is selected.
ON	Select this when the player is connected to an audio component having a built-in DTS decoder. If the player is connected to an audio component lacking a built-in DTS decoder, do not set this. Otherwise, when you play the DTS sound track, a loud noise (or no sound) will come out from the speakers, affecting your ears or causing the speakers to be damaged.

Troubleshooting

If you experience any of the following difficulties while using the CD/DVD player, use this troubleshooting guide to help remedy the problem before requesting repairs. Should any problem persist, consult your nearest Sony dealer.

Power

The power is not turned on.

- ➔ Check that the AC power cord is connected securely.

Picture

There is no picture.

- ➔ The connecting cords are not connected securely.
- ➔ The connecting cords are damaged.
- ➔ The CD/DVD player is not connected to the correct TV input jack (page 17).
- ➔ The video input on the TV is not set so that you can view pictures from the CD/DVD player.

Picture noise appears.

- ➔ The disc is dirty or flawed.
- ➔ If the picture output from your CD/DVD player goes through your VCR to get to your TV, the copy-protection signal applied to some DVD programs could affect picture quality. If you still experience problems even when you connect your CD/DVD player directly to your TV, please try connecting your CD/DVD player to your TV's S video input (page 17).

Even though you set the aspect ratio in "TV TYPE" of "SCREEN SETUP," the picture does not fill the screen.

- ➔ The aspect ratio of the disc is fixed on your DVD.

Sound

There is no sound.

- ➔ The connecting cord is not connected securely.
- ➔ The connecting cord is damaged.
- ➔ The CD/DVD player is connected to the wrong input connector on the amplifier (receiver) (page 21, 22, 23).
- ➔ The amplifier (receiver) input was not changed so that you can listen to the CD/DVD player.
- ➔ The CD/DVD player is in pause mode or in Slow-motion Play mode.
- ➔ The CD/DVD player is in fast forward or fast reverse mode.
- ➔ If the audio signal does not come through the DIGITAL OUT (OPTICAL and COAXIAL) jacks, check the audio settings (page 58).

Sound is noisy.

- ➔ The disc is dirty or flawed.
- ➔ When playing a CD with DTS sound tracks, noise will come from the LINE OUT L/R (AUDIO) 1/2 jacks (page 29).

Sound distortion occurs.

- ➔ Set "AUDIO ATT" in "AUDIO SETUP" to "ON" (page 58).

Operation

The remote does not function.

- ➔ There are obstacles between the remote and the CD/DVD player.
- ➔ The distance between the remote and the CD/DVD player is too far.
- ➔ The remote is not pointed at the remote sensor on the CD/DVD player.
- ➔ The batteries in the remote are weak.

The disc does not play.

- ➔ There is no disc inside.
- ➔ The disc is turned over.
Insert the disc with the playback side facing down on the disc tray.
- ➔ The disc is skewed.
- ➔ The CD/DVD player cannot play CD-ROMs, etc. (page 6).
- ➔ The region code on the DVD does not match the CD/DVD player.
- ➔ Moisture has condensed inside the CD/DVD player. Remove the disc and leave the CD/DVD player turned on for about half an hour. Turn on the power again before playing the disc (page 3).

The disc does not start playing from the beginning.

- ➔ Program Play, Shuffle Play, Repeat Play, or A-B Repeat Play has been selected (page 33). Press CLEAR to cancel these functions before playing a disc.
- ➔ Resume Play has been selected.
During stop, press ■ on the CD/DVD player or the remote and then start playback (page 30).
- ➔ The title, DVD or PBC menu automatically appears on the TV screen.

The CD/DVD player starts playing the disc automatically.

- ➔ The DVD features an auto playback function.
- ➔ “AUTO PLAY” in “CUSTOM SETUP” is set to “TIMER” (page 57).

Playback stops automatically.

- ➔ Some discs may contain an auto pause signal. While playing such a disc, the CD/DVD player stops playback at the auto pause signal.

You cannot perform some functions such as stop, Scan, Slow-motion play, Repeat Play, Shuffle Play, or Program Play.

- ➔ Depending on the disc, you may not be able to do some of the operations above. See the operating manual that comes with the disc.

Messages do not appear on the screen in the language you want.

- ➔ In the Setup Display, select the desired language for the on-screen display in “OSD” under “LANGUAGE SETUP” (page 55).

The language for the sound track cannot be changed.

- ➔ Multilingual tracks are not recorded on the DVD being played.
- ➔ The DVD prohibits the changing of the language for the sound track.

The subtitle language cannot be changed.

- ➔ Multilingual subtitles are not recorded on the DVD being played.
- ➔ The DVD prohibits the changing of the subtitles.

The subtitle cannot be turned off.

- ➔ The DVD prohibits the subtitles being turned off.

The angles cannot be changed.

- ➔ Multi-angles are not recorded on the DVD being played. The angle can be changed when the “ANGLE” indicator lights up on the front panel display (page 9).
- ➔ The DVD prohibits changing of the angles.

The CD/DVD player does not operate properly.

- ➔ When static electricity, etc., causes the CD/DVD player to operate abnormally, press POWER on the player to turn the CD/DVD player off and then on again.

Nothing is displayed on the front panel display.

- ➔ “DIMMER” in “CUSTOM SETUP” is set to “OFF.” Set “DIMMER” to “BRIGHT” or “DARK” (page 57).

5 numbers or letters are displayed on the screen and on the front panel display.

- ➔ The self-diagnosis function was activated. (See the table on page 63.)

The disc tray does not open and “LOCKED” appears on the front panel display.

- ➔ Contact your Sony dealer or local authorized Sony service facility.
-

Self-diagnosis Function

(When letters/numbers appear in the display)

When the self-diagnosis function is activated to prevent the player from malfunctioning, a five-character service number (e.g., C 13 00) with a combination of a letter and digits appears on the screen and the front panel display. In this case, check the following table.

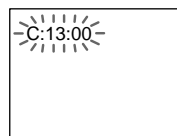

First three characters of the service number	Cause and/or corrective action
C 13	The disc is dirty. ➔ Clean the disc with a soft cloth (page 7).
C 31	The disc is not inserted correctly. ➔ Re-insert the disc correctly.
E XX (xx is a number)	To prevent a malfunction, the player has performed the self-diagnosis function. ➔ Contact your nearest Sony dealer or local authorized Sony service facility and give the 5-character service number. Example: E 61 10

Glossary

Chapter (page 9)

Sections of a picture or a music feature that are smaller than titles. A title is composed of several chapters. Depending on the disc, no chapters may be recorded.

Dolby Digital (page 23, 59)

Digital audio compression technology developed by Dolby Laboratories. This technology conforms to 5.1-channel surround sound. The rear channel is stereo and there is a discrete subwoofer channel in this format. Dolby Digital provides the same 5.1 discrete channels of high quality digital audio found in Dolby Digital cinema audio systems. Good channel separation is realized because all of the channel data is recorded discretely and little deterioration is realized because all channel data processing is digital.

Dolby Surround (Pro Logic) (page 22)

Audio signal processing technology that Dolby Laboratories developed for surround sound. When the input signal contains a surround component, the Pro Logic process outputs the front, center and rear signals. The rear channel is monaural.

DTS (page 23, 60)

Digital audio compression technology that Digital Theater Systems, Inc. developed. This technology conforms to 5.1-channel surround sound. The rear channel is stereo and there is a discrete subwoofer channel in this format. DTS provides the same 5.1 discrete channels of high quality digital audio. Good channel separation is realized because all of the channel data is recorded discretely and little deterioration is realized because all channel data processing is digital.

DVD (page 6)

A disc that contains up to 8 hours of moving pictures even though its diameter is the same as a CD.

The data capacity of a single-layer and single-sided DVD is 4.7 GB (Giga Byte), which is 7 times that of a CD. The data capacity of a double-layer and single-sided DVD is 8.5 GB, a single-layer and double-sided DVD is 9.4 GB, and double-layer and double-sided DVD is 17 GB.

The picture data uses the MPEG 2 format, one of the worldwide standards of digital compression technology. The picture data is compressed to about 1/40 (average) of its original size. The DVD also uses a variable rate coding technology that changes the data to be allocated according to the status of the picture. Audio information is recorded in Dolby Digital as well as in PCM, allowing you to enjoy a more real audio presence. Furthermore, various advanced functions such as the multi-angle, multilingual, and Parental Control functions are provided with the DVD.

Index (CD)/Video Index (VIDEO CD) (page 9)

A number that divides a track into sections to easily locate the point you want on a VIDEO CD or CD. Depending on the disc, no index may be recorded.

Parental Control (page 47)

A function of the DVD used to limit playback of the disc according to the age of the user and the limitation level in each country. The limitation varies from disc to disc; when it is activated, or playback is completely prohibited, violent scenes are skipped or replaced with other scenes, etc.

Region Code (page 6)

This system is used to protect copyrights. A region number is allocated on each DVD player or DVD disc according to the sales region. Each region code is shown on the player as well as on the disc packaging. The

player can play the discs that match its region code. This player can also play discs with the “” mark. Even when the region code is not shown on the DVD, the region limit may still be activated.

Scene (page 9)

On a VIDEO CD with PBC (playback control) functions, the menu screens, moving pictures and still pictures are divided into sections called “scenes.”

Title (page 9)

The longest section of a picture or music feature on a DVD, movie, etc., in video software, or the entire album in audio software.

Track (page 9)

Sections of a picture or a music feature on a VIDEO CD or CD (the length of a song).

TV Virtual Surround (TVS) (page 43)

Technology from Sony developed to produce surround sound for home use using just a stereo TV. Designed to work with the sound characteristics of your TV, this technology brings the excitement of surround sound to your home using nothing more than your stereo TV’s internal speakers. Furthermore, various TVS modes are available. For example, TVS WIDE uses just two speakers to create a virtual sound environment that makes you feel like you are surrounded by multiple speakers.

Specifications

System

Laser	Semiconductor laser
Signal format system	NTSC

Audio characteristics

Frequency response	DVD (PCM 96 kHz): 2 Hz to 44 kHz (± 1.0 dB) DVD (PCM 48 kHz): 2 Hz to 22 kHz (± 0.5 dB) CD: 2 Hz to 20 kHz (± 0.5 dB)
Signal-to-noise ratio (S/N ratio)	115 dB (LINE OUT L/R (AUDIO) jacks 1, 2 only)
Harmonic distortion	0.003 %
Dynamic range	DVD: 103 dB CD: 99 dB
Wow and flutter	Less than detected value ($\pm 0.001\%$ W PEAK)

The signals from LINE OUT L/R (AUDIO) 1/2 jacks are measured. When you play PCM sound tracks with a 96 kHz sampling frequency, the output signals from the DIGITAL OUT (COAXIAL and OPTICAL) jacks are converted to 48 kHz sampling frequency.

Outputs

Jack name	Jack type	Maximum output level	Load impedance
DIGITAL OUT (OPTICAL)	Optical output jack	-18 dBm	Wave length: 660 nm
DIGITAL OUT (COAXIAL)	Phono jack	0.5 Vp-p	75 ohms terminated
LINE OUT (AUDIO) (1, 2)	Phono jack	2 Vrms (50 kilohms)	Over 10 kilohms
LINE OUT (VIDEO) (1, 2)	Phono jack	1.0 Vp-p	75 ohms, sync negative
S VIDEO OUT	4-pin mini DIN	Luminance signal: 1.0 Vp-p Color signal: 0.286 Vp-p	75 ohms, sync negative 75 ohms terminated
COMPONENT VIDEO OUT (Y, P _B , P _R)	Phono jack	Y: 1.0 Vp-p P _B , P _R : 0.7 Vp-p	75 ohms, sync negative 75 ohms terminated

General

Power requirements	120V AC, 60 Hz 110 to 240V AC, 50/60 Hz See page 3 for further information.
Power consumption	12 W See page 3 for further information.
Dimensions (approx.)	430 × 74 × 256 mm (17 × 3 × 10 1/8 in.) (width/height/depth) incl. projecting parts
Mass (approx.)	2.7 kg (5 lb)
Operating temperature	5 °C to 35 °C (41 °F to 95 °F)
Operating humidity	25 % to 80 %

Supplied accessories

See page 14.

Specifications and design are subject to change without notice.

ENERGY STAR® is a U.S. registered mark. As an ENERGY STAR® Partner, Sony Corporation has determined that this product meets the ENERGY STAR® guidelines for energy efficiency.

Language Code List

For details, see page 42, 55, 45.

The language spellings conform to the ISO 639: 1988 (E/F) standard.

Code Language	Code Language	Code Language	Code Language
1027 Afar	1183 Irish	1347 Maori	1507 Samoan
1028 Abkhazian	1186 Scots Gaelic	1349 Macedonian	1508 Shona
1032 Afrikaans	1194 Galician	1350 Malayalam	1509 Somali
1039 Amharic	1196 Guarani	1352 Mongolian	1511 Albanian
1044 Arabic	1203 Gujarati	1353 Moldavian	1512 Serbian
1045 Assamese	1209 Hausa	1356 Marathi	1513 Siswati
1051 Aymara	1217 Hindi	1357 Malay	1514 Sesotho
1052 Azerbaijani	1226 Croatian	1358 Maltese	1515 Sundanese
1053 Bashkir	1229 Hungarian	1363 Burmese	1516 Swedish
1057 Byelorussian	1233 Armenian	1365 Nauru	1517 Swahili
1059 Bulgarian	1235 Interlingua	1369 Nepali	1521 Tamil
1060 Bihari	1239 Interlingue	1376 Dutch	1525 Telugu
1061 Bislama	1245 Inupiak	1379 Norwegian	1527 Tajik
1066 Bengali; Bangla	1248 Indonesian	1393 Occitan	1528 Thai
1067 Tibetan	1253 Icelandic	1403 (Afan)Oromo	1529 Tigrinya
1070 Breton	1254 Italian	1408 Oriya	1531 Turkmen
1079 Catalan	1257 Hebrew	1417 Punjabi	1532 Tagalog
1093 Corsican	1261 Japanese	1428 Polish	1534 Setswana
1097 Czech	1269 Yiddish	1435 Pashto; Pushto	1535 Tonga
1103 Welsh	1283 Javanese	1436 Portuguese	1538 Turkish
1105 Danish	1287 Georgian	1463 Quechua	1539 Tsonga
1109 German	1297 Kazakh	1481 Rhaeto- Romance	1540 Tatar
1130 Bhutani	1298 Greenlandic	1482 Kirundi	1543 Twi
1142 Greek	1299 Cambodian	1483 Romanian	1557 Ukrainian
1144 English	1300 Kannada	1489 Russian	1564 Urdu
1145 Esperanto	1301 Korean	1491 Kinyarwanda	1572 Uzbek
1149 Spanish	1305 Kashmiri	1495 Sanskrit	1581 Vietnamese
1150 Estonian	1307 Kurdish	1498 Sindhi	1587 Volapük
1151 Basque	1311 Kirghiz	1501 Sangho	1613 Wolof
1157 Persian	1313 Latin	1502 Serbo-Croatian	1632 Xhosa
1165 Finnish	1326 Lingala	1503 Singhalese	1665 Yoruba
1166 Fiji	1327 Laothian	1505 Slovak	1684 Chinese
1171 Faroese	1332 Lithuanian	1506 Slovenian	1697 Zulu
1174 French	1334 Latvian; Lettish		
1181 Frisian	1345 Malagasy		
			1703 Not specified

List of Setup Display Items

The default settings are underlined.



LANGUAGE SETUP (page 55)

OSD	<u>ENGLISH</u> FRENCH SPANISH PORTUGUESE
DVD MENU	<u>ENGLISH</u> FRENCH SPANISH PORTUGUESE GERMAN ITALIAN DUTCH CHINESE JAPANESE DANISH SWEDISH FINNISH NORWEGIAN RUSSIAN OTHERS →
AUDIO	<u>ORIGINAL</u> (All other selections are same as the DVD MENU language.)
SUBTITLE	<u>AUDIO FOLLOW</u> (All other selections are same as the DVD MENU language.)



SCREEN SETUP (page 56)

TV TYPE	<u>4:3 LETTER BOX</u> 4:3 PAN SCAN 16:9
SCREEN SAVER	<u>ON</u> OFF
BACKGROUND	<u>JACKET PICTURE</u> GRAPHICS BLUE BLACK

**CUSTOM SETUP (page 57)**

AUTO PLAY	<u>OFF</u> TIMER DEMO1 DEMO2
DIMMER	<u>BRIGHT</u> DARK OFF
PAUSE MODE	<u>AUTO</u> FRAME
PARENTAL CONTROL →	
TRACK SELECTION	<u>OFF</u> AUTO

**AUDIO SETUP (page 58)**

AUDIO ATT	<u>OFF</u> ON		
AUDIO DRC	<u>STANDARD</u> TV MODE WIDE RANGE		
DOWNMIX	<u>DOLBY SURROUND</u> NORMAL		
DIGITAL OUT	<u>ON</u>	DOLBY DIGITAL	<u>D-PCM</u> DOLBY DIGITAL
		DTS	<u>OFF</u> ON
	OFF		

Index

Numerics

- 16:9 56
- 4:3 LETTER BOX 56
- 4:3 PAN SCAN 56
- 5.1 Channel Surround 23

A

- A-B Repeat 36
- ANGLE 45
- AUDIO 55
- AUDIO ATT 58
- AUDIO DRC 58
- AUDIO SETUP 58
- AUTO PLAY 57

B

- BACKGROUND 57
- Batteries 14
- BNR 46

C

- CD 28
- CHAPTER 38
- Chapter 64
- Connecting 17
- Continuous play
 - CD/VIDEO
 - CD/DVD 28
- Control Bar 13
- Control Menu 13
- CUSTOM 54
- CUSTOM PARENTAL
 - CONTROL 47
- CUSTOM SETUP 57

D

- DIGITAL OUT 59
- Digital output 59
- DIMMER 57
- Display
 - Control Menu display 13
 - Front panel display 9
 - Setup Display 12
- DOLBY DIGITAL 22, 43, 59
- DOWNMIX 59
- DTS 22, 42, 60
- DVD 28, 64
- DVD MENU 55

- DVD menu 31

F

- Fast forward 37
- Fast reverse 37
- Front Panel display 9

H

- Handling discs 7
- Hooking up 17

I

- INDEX 38
- Index 38
- INSTANT REPLAY 29

L

- LANGUAGE SETUP 55
- Locating
 - a specific point by
 - watching the TV screen 37

N

- Number input 38

O

- On-screen display
 - Control Menu display 13
 - Setup Display 54
- OSD 68

P

- PARENTAL CONTROL 47, 58
- PAUSE MODE 58
- PBC Playback 32
- PROGRAM 33
- Program Play 33

Q

- QUICK 55
- Quick Setup 24

R

- Remote 14, 53
- REPEAT 35
- RESET 55

- Resume Play 30

S

- S VIDEO output 17
- SCENE 38
- Scene 65
- SCREEN SAVER 57
- SCREEN SETUP 56
- Setup Display 54
- SHUFFLE 35
- Shuffle Play 35
- Slow-motion play 37
- Speakers hookup 21
- Status Bar 12
- SUBTITLE 55
- Subtitles 45
- SURROUND 43

T

- TIME/TEXT 39
- TITLE 38
- Title 65
- Title menu 31
- TRACK 38
- Track 65
- TRACK SELECTION 58
- Troubleshooting 61
- TV TYPE 56
- TVS (TV Virtual Surround) 43

U

- Usable discs 6

V

- VIDEO CD 28

