

---

# NAD<sup>®</sup> T524

DVD / CD / MP3 Player

---



---

Owner's Manual  
Manuel de l'utilisateur  
Bedienungsanleitung  
Gebruikershandleiding

ENGLISH

FRANÇAIS

DEUTSCH

NEDERLANDS

# Introduction

## SAFETY PRECAUTIONS

**CAUTION**  
**RISK OF ELECTRIC SHOCK**  
**DO NOT OPEN**



**WARNING: TO REDUCE THE RISK OF ELECTRIC SHOCK, DO NOT REMOVE THE COVER OR BACK OF THIS PRODUCT. THERE ARE NO USER-SERVICEABLE PARTS INSIDE. REFER SERVICING TO QUALIFIED SERVICE PERSONNEL.**



**WARNING: TO REDUCE THE RISK OF FIRE OR ELECTRIC SHOCK, DO NOT EXPOSE THIS PRODUCT TO DRIPPING OR SPLASHING WATER, RAIN, OR MOISTURE. DO NOT PLACE OBJECTS FILLED WITH WATER SUCH AS VASES, ON THE PRODUCT.**

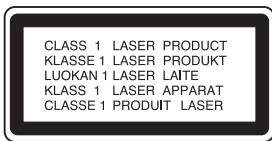

**WARNING: THIS DIGITAL VERSATILE DISC PLAYER EMPLOYS A LASER SYSTEM. USE OF CONTROLS, ADJUSTMENTS, OR THE PERFORMANCE OF PROCEDURES OTHER THAN THOSE SPECIFIED HEREIN MAY RESULT IN HAZARDOUS RADIATION EXPOSURE.**



**WARNING: TO PREVENT DIRECT EXPOSURE TO LASER BEAM, DO NOT OPEN THE ENCLOSURE. VISIBLE LASER RADIATION WHEN OPEN.**



**WARNING: NEVER STARE DIRECTLY INTO THE LASER BEAM.**



**CAUTION**  
**DO NOT INSTALL THIS PRODUCT IN A CONFINED SPACE SUCH AS A BOOK CASE OR SIMILAR UNIT.**



This product is manufactured to comply with the radio interference requirements of EEC DIRECTIVE 89/336/EEC, 93/68/EEC and 73/23/EEC.



### NOTES ON COPYRIGHT

It is forbidden by law to copy, broadcast, show, broadcast via cable, play in public, or rent copyrighted material without permission. This product features the copy protection function developed by Macrovision. Copy protection signals are recorded on some discs. When recording and playing the pictures of these discs picture noise will appear. This product incorporates copyright protection technology that is protected by method claims of certain U.S. patents and other intellectual property rights owned by Macrovision Corporation and other rights owners. Use of this copyright protection technology must be authorized by Macrovision Corporation, and is intended for home and other limited viewing uses only unless otherwise authorized by Macrovision Corporation. Reverse engineering or disassembly is prohibited.

CONSUMERS SHOULD NOTE THAT NOT ALL HIGH DEFINITION TELEVISION SETS ARE FULLY COMPATIBLE WITH THIS PRODUCT AND MAY CAUSE ARTIFACTS TO BE DISPLAYED IN THE PICTURE. IN CASE OF 525 OR 625 PROGRESSIVE SCAN PICTURE PROBLEMS, IT IS RECOMMENDED THAT THE USER SWITCH THE CONNECTION TO THE 'STANDARD DEFINITION' OUTPUT. IF THERE ARE QUESTIONS REGARDING OUR TV SET COMPATIBILITY WITH THIS MODEL 525p AND 625p DVD PLAYER, PLEASE CONTACT OUR CUSTOMER SERVICE CENTER.

### SERIAL NUMBER:

You can find the serial number on the back of the unit. This number is unique to this unit and not available to others. You should record requested information here and retain this guide as a permanent record of your purchase.

**MODEL NO.** \_\_\_\_\_  
**SERIAL NO.** \_\_\_\_\_  
**DATE OF PURCHASE** \_\_\_\_\_



<b>INTRODUCTION</b>	
Safety precautions	.2
<b>Before use</b>	<b>.4</b>
Symbol used in this Manual	.4
About the (Ⓢ) Symbol Display	.4
Notes on Discs	.4
Types of Playable Discs	.5
Disc-related terms	.6
<b>Front Panel and Display Window</b>	<b>.7</b>
<b>Rear Panel</b>	<b>.8</b>
<b>Remote Control</b>	<b>.9</b>
<b>INSTALLATION AND SETUP</b>	
<b>Connections</b>	<b>.10</b>
Setting up the Player	.10
DVD Player Connections	.10
Audio Connection to Optional Equipment	.11
<b>Before operation</b>	<b>.11</b>
On-Screen Display	.12
Initial Settings	.13
Language	.13
Display	.13
AUDIO	.14
Others	.15
LOCK (Parental Control)	.16
<b>OPERATION</b>	
<b>Operation with DVD and Video CD</b>	<b>.17</b>
Playing a DVD or Video CD	.17
General Features	.17
Special DVD Features	.19
DVD Audio Discs	.20
<b>Operation with Audio CD and MP3 / WMA Disc</b>	<b>.21</b>
Playing an Audio CD or MP3/WMA Disc	.21
Audio CD and MP3 / WMA Disc Features	.22
<b>Programmed Playback</b>	<b>.23</b>
<b>Operation with JPEG Disc</b>	<b>.24</b>
Viewing a JPEG Disc	.24
<b>Operation with a DVD VR format Disc</b>	<b>.25</b>
Maintenance and Service	.25
<b>Operation with a DivX Movie Disc</b>	<b>.26</b>
<b>Additional Information</b>	<b>.27</b>
Additional Features	.27
<b>Speaker Setup</b>	<b>.28</b>
<b>REFERENCE</b>	
<b>Troubleshooting</b>	<b>.29</b>
<b>Table of Languages and their Codes</b>	<b>.30</b>
<b>Country Codes List</b>	<b>.31</b>
<b>Specifications</b>	<b>.32</b>

# Introduction

## BEFORE USE

To ensure proper use of this product, please read this owner's manual carefully and retain for future reference.

This manual provides information on the operation and maintenance of your DVD player. Should the unit require service, contact an authorized service location.

### SYMBOL USED IN THIS MANUAL

 The lightning flash symbol alerts you to the presence of dangerous voltage within the product enclosure that may constitute a risk of electric shock.

 The exclamation mark alerts you to the presence of important operating and maintenance / servicing instructions.

 Indicates hazards likely to cause harm to the unit itself or other material damage.

**NOTE:**  
Indicates special notes and operating features.

**TIP:**  
Indicates tips and hints for making the task easier.

A section whose title has one of the following symbols is applicable only to the disc represented by the symbol.

-  DVD and finalized DVD±R/RW
-  DVD Audio discs
-  Video CDs
-  Audio CDs
-  MP3 Discs
-  WMA Discs
-  JPEG Discs
-  DivX Discs

### ABOUT THE SYMBOL DISPLAY

"" may appear on your TV display during operation and indicates that the function explained in this owner's manual is not available on that specific DVD video disc.

### NOTES ON DISCS

#### HANDLING DISCS

Do not touch the playback side of the disc. Hold the disc by the edges so that fingerprints do not get on the surface. Never stick paper or tape on the disc.

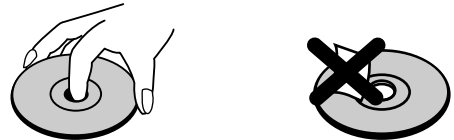

#### STORING DISCS

After playing, store the disc in its case. Do not expose the disc to direct sunlight or sources of heat and never leave it in a parked car exposed to direct sunlight.

#### CLEANING DISCS

Fingerprints and dust on the disc can cause poor picture quality and sound distortion. Before playing, clean the disc with a clean cloth. Wipe the disc from the centre out.

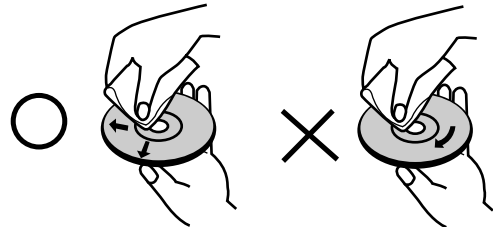

Do not use strong solvents such as alcohol, benzine, thinner, commercially available cleaners, or anti-static spray intended for older vinyl records.

**TYPES OF PLAYABLE DISCS**

DVD  
(8 cm / 12 cm disc)



DVD audio discs  
(8 cm / 12 cm disc)



Video CD (VCD)  
(8 cm / 12 cm disc)



Audio CD  
(8 cm / 12 cm disc)

In addition, this unit plays DivX file, DVD -R, DVD +R, DVD -RW, DVD +RW, SVCD and CD-R / CD-RW that contains audio titles, MP3, WMA, and/or JPEG files.



This indicates a product feature that is capable of playing DVD-RW discs recorded with Video Recording format.

**NOTES**

- Depending on the conditions of the recording equipment or the CD-R/RW (or DVD -R, DVD +R, DVD -RW, DVD +RW) disc itself, some CD-R/RW (or DVD -R, DVD +R, DVD -RW, DVD +RW) discs cannot be played on the unit.
- Do not attach any seal or label to either side (the labelled side or the recorded side) of a disc.
- Do not use irregularly shaped CDs (e.g., heart-shaped or octagonal) since they may result in malfunctions.

**NOTES ON DVDS AND VIDEO CDS**

Some playback operations of DVDs and Video CDs may be intentionally programmed by software manufacturers. This unit plays DVDs and Video CDs according to disc content designed by the software manufacturer, therefore some playback features may not be available or other functions may be added.

**MANUFACTURED UNDER LICENCE FROM DOLBY LABORATORIES. "DOLBY", "PRO LOGIC", "MLP LOSSLESS", AND THE DOUBLE-D SYMBOL ARE TRADEMARKS OF DOLBY LABORATORIES.**

**DTS AND DTS DIGITAL OUT ARE TRADEMARKS OF DIGITAL THEATER SYSTEMS, INC.**

**REGIONAL CODE**

This DVD player is designed and manufactured for playback of region "2" encoded DVD software. This unit can play only DVD discs labeled "2" or "ALL".

**NOTES ON REGIONAL CODES**

- Most DVD discs have a globe with one or more numbers in it clearly visible on the cover. This number must match your DVD player's regional code or the disc cannot play.
- If you try to play a DVD with a different region code from your player, the message "Check Regional Code" appears on the TV screen.

# Introduction

## BEFORE USE

### DISC-RELATED TERMS

#### DVD ±R / DVD ±RW

DVD -R and DVD +R are two different standards for recordable DVD drives and discs. This format allows information to be recorded onto the DVD disc only once. DVD +RW and DVD -RW are two standards for re-writable media, meaning the DVD content can be erased and re-recorded. Single-sided discs can hold 4.38 Gigabytes and double-sided discs hold twice as much. There are no dual layer single sided recordable discs.

#### VCD (VIDEO CD)

A VCD holds up to 74 minutes (650 MB disc) or 80 minutes (700 MB disc) of MPEG-1 full-motion video along with quality stereo sound.

#### MPEG

MPEG is an international standard for video and audio compression. MPEG-1 is used in encoding video for VCD and provides for multichannel surround sound coding such as PCM, Dolby Digital, DTS and MPEG audio.

#### MP3

MP3 is a popular compression format used for digital audio files that yields very high near-CD quality.

#### WMA

Windows media audio file. A type of coding / decoding developed by Microsoft Corp.

#### JPEG

Joint Pictures Expert Group. JPEG is a compressed file format that allows you to save images with no limit on the number of colors.

#### DIVX

DivX is the name of a revolutionary new video codec which is based on the new MPEG-4 compression standard for video. You will be able to play DivX movies using this DVD player.

#### PBC: PLAYBACK CONTROL (VIDEO CD ONLY)

Playback control is available for Video CD (VCD) version 2.0 disc formats. PBC allows you to interact with the system via menus, search functions, or other typical computer-like operations. Moreover, still pictures of high resolution can be played if they are included in the disc. Video CDs not equipped with PBC (Version 1.1) operate in the same way as audio CDs.

#### TITLE (DVD VIDEO DISCS ONLY)

A title is generally a distinct section of a DVD disc. For example the main feature could be title 1, a documentary describing how the film was made could be title 2, and cast interviews could be title 3. Each title is assigned a reference number enabling you to locate it easily.

#### CHAPTER (DVD VIDEO DISCS ONLY)

A chapter is a segment of a title such as a scene in a film or one interview in a series. Each chapter is assigned a chapter number, enabling you to locate the chapter you want. Depending on the disc, chapters may not be recorded.

#### GROUP (DVD AUDIO DISCS ONLY)

The main audio content or accompanying feature content or additional feature content, or music album. Each group is assigned a group reference number enabling you to locate it easily.

#### SCENE (VCD)

On a video CD with PBC (playback control) functions, moving pictures and still pictures are divided into sections called "scenes". Each scene is displayed in the menu screen and assigned a scene number, enabling you to locate the scene you want. A scene is composed of one or several tracks.

#### TRACK

A distinct element of audiovisual information, such as the picture or sound track for a specific language (DVD), or a musical piece on a video or audio CD. Each track is assigned a track number, enabling you to locate the track you want. DVD discs allow one track of video (with multiple angles) and several tracks of audio.

**Front Panel**

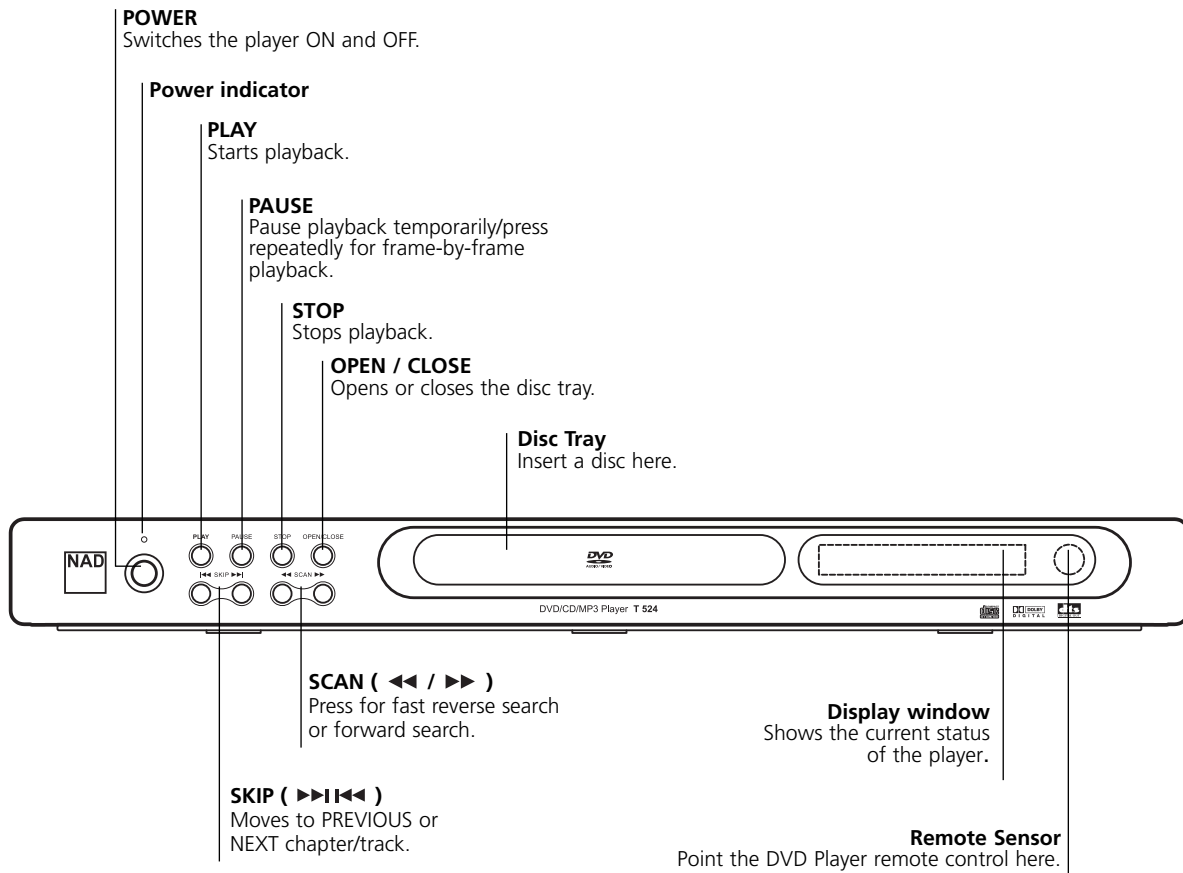

**Display Window**

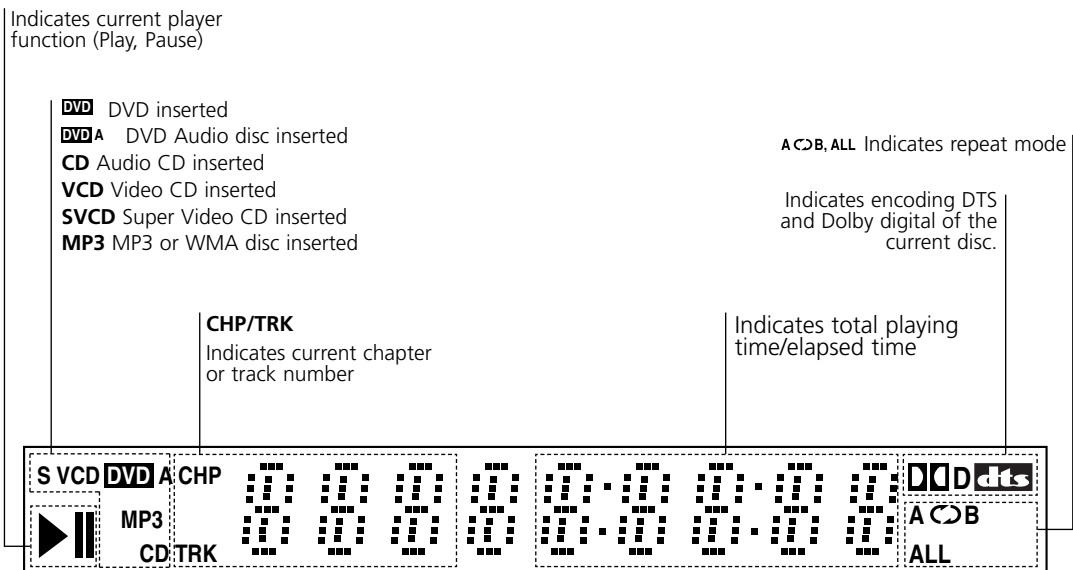

ENGLISH

# Introduction

## REAR PANEL

ENGLISH

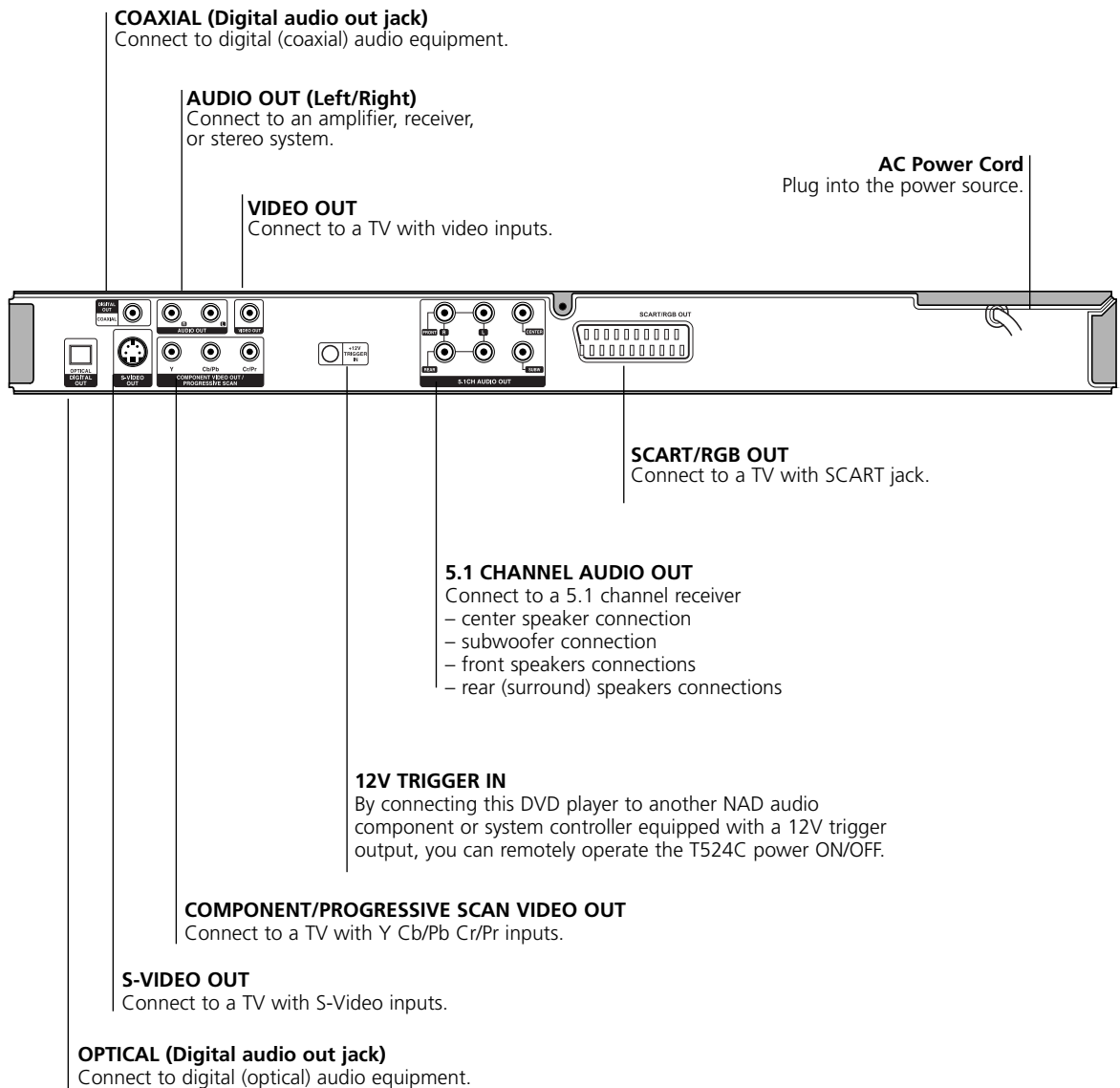



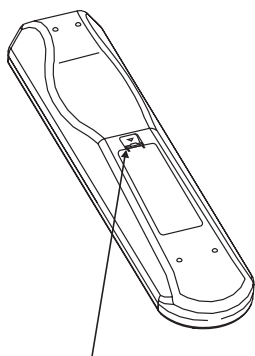
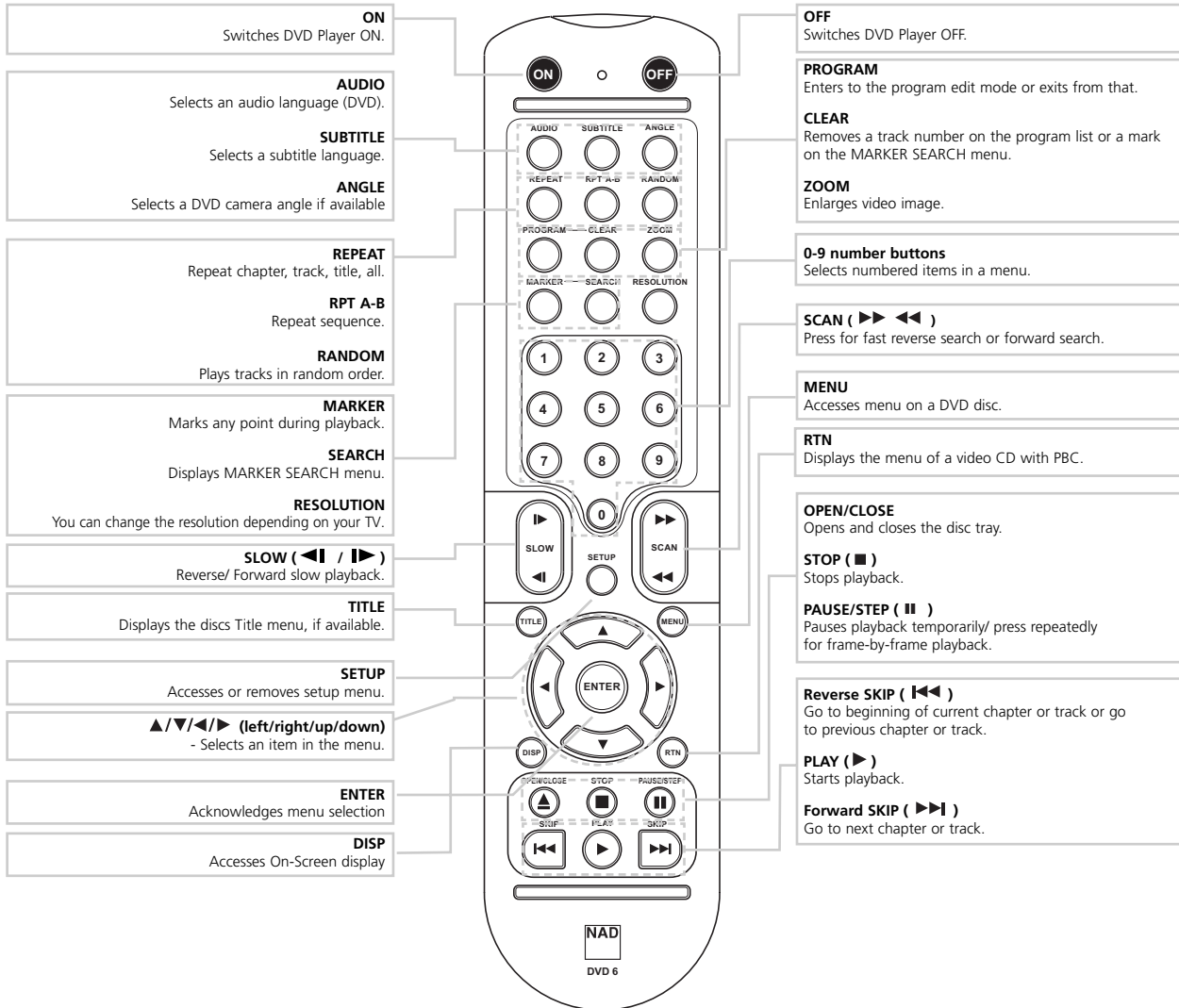

PRESS IN AND LIFT TAB TO REMOVE BATTERY COVER OUT FROM RECESS

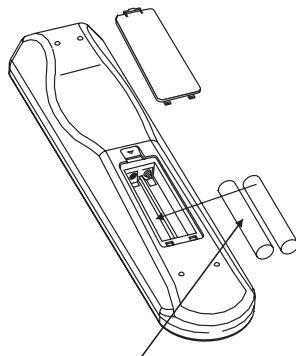

PLACE BATTERIES INTO OPENING. ENSURE THE CORRECT POLARITY IS OBSERVED

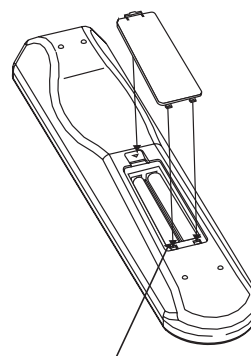

REPLACE BATTERY COVER BY ALIGNING AND INSERTING THE TWO TABS INTO THE HOLES.

PRESS BATTERY COVER INTO PLACE UNTIL IT 'CLICKS' CLOSED

# Installation and Setup

## CONNECTIONS

### SETTING UP THE PLAYER

The picture and sound of a nearby TV, VCR, or radio may be distorted during playback. If this occurs, position the player away from the TV, VCR, or radio, or turn off the unit after removing the disc.

### DVD PLAYER CONNECTIONS

Depending on your TV and other equipment there are various ways you can connect the player. Please refer to the manuals of your TV, stereo system or other devices as necessary for additional connection information.

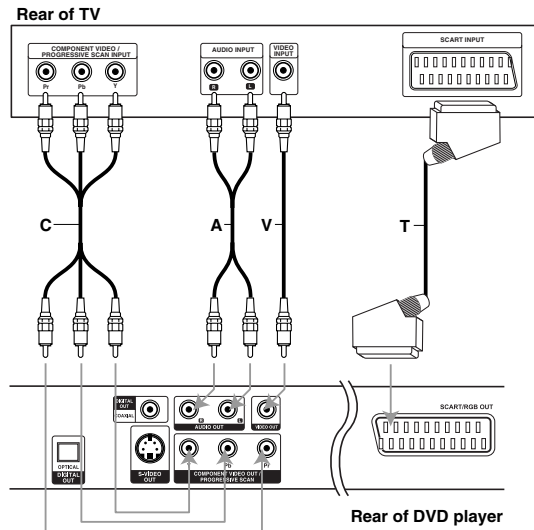

### CAUTION

You must set the TV Output Select option to use COMPONENT VIDEO OUT/PROGRESSIVE SCAN and SCART jacks. (See "TV Output Select" on page 14.)

### Video and Audio Connections to Your TV

Make sure the DVD player is connected directly to the TV and not to a VCR, otherwise the DVD image could be distorted by the copy protection system.

#### Video

Connect the VIDEO OUT jack on the DVD player to the video in jack on the TV using the video cable (**V**).

#### SCART connection

Connect the TO TV SCART jack on the DVD Player to the corresponding in jacks on the TV using the SCART cable (**T**).

#### Component Video (Color Stream®)

Connect the COMPONENT VIDEO OUT/PROGRESSIVE SCAN jacks on the DVD Player to the corresponding in jacks on the TV using an Y Pb Pr cable (**C**).

#### PROGRESSIVE SCAN (COLORSTREAM® PRO):

- If your television is a high-definition or "digital ready" television, you may take advantage of the DVD Player's progressive scan output for the highest video resolution possible.
- If your TV does not accept the Progressive Scan format, the picture will appear scrambled if you try Progressive Scan on the DVD Player.

#### NOTES

- Set the Progressive to "On" on the setup menu for progressive signal, see page 14.
- Set the progressive to "Off" by removing any disc from the unit and close the disc tray. see that "no disc" is displayed on the display window. Then press STOP and hold it for five seconds before releasing it.
- Progressive scan does not work with the analogue video connections (yellow VIDEO OUT jack).

#### Audio Connection to Your TV:

Connect the left and right AUDIO OUT jacks of the DVD Player to the audio left and right IN jacks on the TV (**A**) using the audio cables. Do not connect the DVD Player's AUDIO OUT jack to the Phono In jack (record deck) of your audio system.

### AUDIO CONNECTION TO OPTIONAL EQUIPMENT

Connect the DVD player to your optional equipment for audio output.

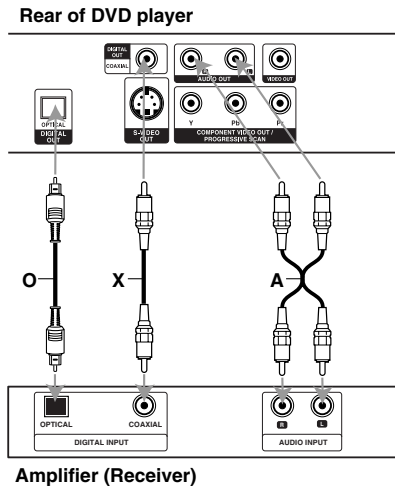

#### Amplifier equipped with 2-channel analogue stereo or Dolby Pro Logic II / Pro Logic

Connect the left and right AUDIO OUT jacks on the DVD player to the audio left and right IN jacks on your amplifier, receiver, or stereo system, using the audio cables (A).

#### Amplifier equipped with 2-channel digital stereo (PCM) or audio / video receiver equipped with a multi-channel decoder (Dolby Digital™, MPEG 2, or DTS)

- 1 Connect one of the DVD Player's DIGITAL AUDIO OUT jacks (OPTICAL O or COAXIAL X) to the corresponding in jack on your amplifier.
- 2 Use an optional digital (optical O or coaxial X) audio cable.

#### DIGITAL MULTI-CHANNEL SOUND

A digital multi-channel connection provides the best sound quality. For this you need a multi-channel audio / video receiver that supports one or more of the audio formats supported by your DVD player such as MPEG 2, Dolby Digital and DTS. Check the receiver manual and the logos on the front of the receiver.

#### NOTES

- If the audio format of the digital output does not match the capabilities of your receiver, the receiver produces a strong, distorted sound or no sound at all.
- Six Channel Digital Surround Sound via a digital connection can only be obtained if your receiver is equipped with a Digital Multi-channel decoder.
- To see the audio format of the current DVD in the on-screen display, press AUDIO.

#### Analogue connection to a multi-channel A/V receiver with 6 Channel connectors (Dolby Digital)

- 1 This DVD Player contains a multi-channel decoder.
- 2 This enables playback of DVDs recorded in Multi-channel Surround without the need for an optional decoder.

Make the appropriate Sound settings for Analogue Output and Speaker Settings in the setup menu. See page 28.

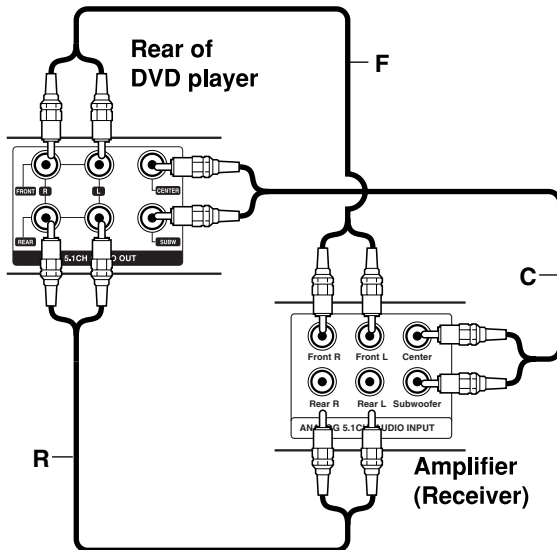

# Installation and Setup

## BEFORE OPERATION

### ON-SCREEN DISPLAY





You can display the general playback status on the TV screen. Some items can be changed using the menu. To use the on-screen display:

- 1 Press DISPLAY during playback.
- 2 Press ▲/▼ to select an item. The selected item is highlighted.
- 3 Press ◀/▶ to change the setting. You can also use the number buttons if appropriate (e.g. inputting the title number). For some functions, press ENTER to execute the setting.



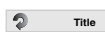

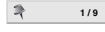
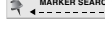
#### NOTES

- Some discs may not provide all of the features shown below.
- If no button is pressed for 10 seconds, the on-screen display disappears.



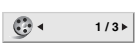

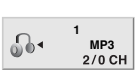
#### PLAYBACK STATUS/RESTRICTIONS

-  Title Repeat title
-  A - B Repeat sequence
-  1 / 9 Enter a Marker
-  MARKER SEARCH Marker Search menu
-  Resume play from this point
-  Action prohibited or not available

#### Example: On-Screen Display during playing DivX movie disc

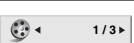
Items		Selection Method
Track Number		◀/▶, Numbers ENTER
Time search		Numbers, ENTER
Audio language and Digital Audio Output mode		◀/▶ or AUDIO
Subtitle language		◀/▶ or SUBTITLE
Sound		◀/▶

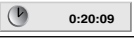
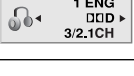
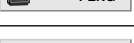
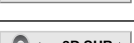

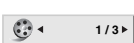
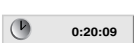
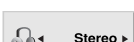
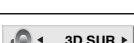

#### Example: On-Screen Display during playing DVD Video

Items		Selection Method
Title Number		▲/▼ ◀/▶, Numbers ENTER
Chapter Number		◀/▶, Numbers ENTER
Time search		Numbers, ENTER
Audio language and Digital Audio Output mode		◀/▶ or AUDIO
Subtitle language		◀/▶ or SUBTITLE
Angle		◀/▶ or ANGLE
Sound		◀/▶

#### Example: On-Screen Display during playing VCD

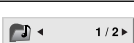
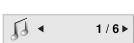
Items		Selection Method
Track Number (or PBC mode)		◀/▶, Numbers ENTER
Time search		Numbers ENTER
Audio Channel		◀/▶ or AUDIO
Sound		◀/▶

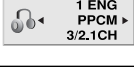
#### Example: On-Screen Display during playing DVD Audio

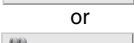
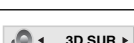
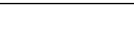
Items		Selection Method
Group Number		◀/▶, Numbers ENTER
Track Number		◀/▶, Numbers ENTER
Time search		Display only
DVD Audio Output mode		◀/▶ or AUDIO
Subtitle language		Display only
Page (or Angle)	 OR 	◀/▶ or ANGLE
Sound		◀/▶

### INITIAL SETTINGS

By using the Setup menu, you can make various adjustments to items such as picture and sound. You can also set a language for the subtitles and the Setup menu, among other things. For details on each Setup menu item, see pages 13 to 16.

#### TO DISPLAY AND EXIT THE MENU:

Press **SETUP** to display the menu. A second press of **SETUP** will take you back to initial screen.

#### To go to the next level:

Press **▶** on the remote control.

#### To go back to the previous level:

Press **◀** on the remote control.

### GENERAL OPERATION

- 1 Press **SETUP**. The Setup menu appears.
- 2 Use **▲/▼** to select the desired option then press **▶** to move to the second level. The screen shows the current setting for the selected item, as well as alternate setting(s).
- 3 Use **▲/▼** to select the second desired option then press **▶** to move to the third level.
- 4 Use **▲/▼** to select the desired setting then press **ENTER** to confirm your selection. Some items require additional steps.
- 5 Press **SETUP** or **PLAY** to exit the Setup menu.

### LANGUAGE

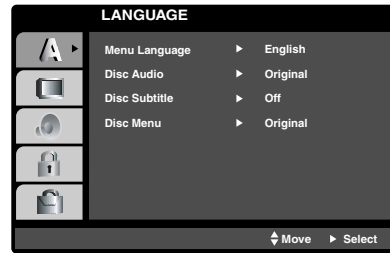

#### MENU LANGUAGE

Select a language for the Setup menu and on-screen display.

#### DISC AUDIO / SUBTITLE / MENU **DVD-V** **DVD-A**

Select the language you prefer for the audio track (disc audio), subtitles, and the disc menu.

**Original:** Refers to the original language in which the disc was recorded.

**Other:** To select another language, press number buttons then **ENTER** to enter the corresponding 4-digit number according to the language code list in the reference chapter. If you enter the wrong language code, press **CLEAR**.

### DISPLAY

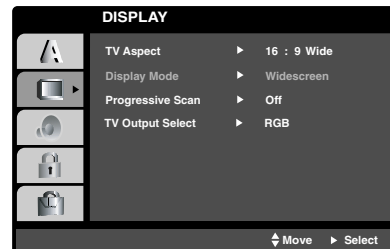

#### TV ASPECT **DVD-V** **DVD-A**

**4:3:** Select when a standard 4:3 TV is connected.

**16:9 Wide:** Select when a 16:9 wide TV is connected.

#### DISPLAY MODE **DVD-V** **DVD-A**

Display Mode setting works only when the TV Aspect mode is set to "4:3".

**Letterbox:** Displays a wide picture with bands on the upper and lower portions of the screen.

**Panscan:** Automatically displays the wide picture on the entire screen and cuts off the portions that do not fit.

# Installation and Setup

## BEFORE OPERATION

### PROGRESSIVE SCAN

Progressive Scan Video provides the highest quality pictures with less flickering.

If you are using the Component Video jacks for connection to a TV or monitor that is compatible with a progressive scan signal, set Progressive Scan to On.

#### TO TURN ON PROGRESSIVE SCAN:

Connect Component out of the DVD to the input of your monitor/television, set your television or monitor to Component Input.

- 1 Select "Progressive Scan" on the DISPLAY menu then press ►.

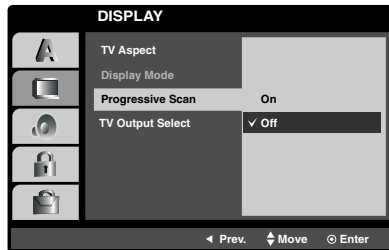

- 2 Select "On" using the ▲/▼ buttons.
- 3 Press ENTER to confirm your selection. The confirm menu will appear.

#### NOTE

If your TV does not accept the Progressive Scan format, the picture will appear scrambled if you try Progressive Scan on the DVD Player.

- 4 When the confirm menu appears on your screen Cancel is highlighted as default. Use the ◀/▶ buttons to highlight Enter.
- 5 Pressing ENTER will set the player to Progressive scan mode.

#### CAUTION

Once the setting for progressive scan output is entered, an image will only be visible on a progressive scan compatible TV or monitor. If you set Progressive Scan to On in error, you must reset the unit. First, remove the disc in the DVD Player. Next, press STOP (■) and hold it for five seconds before releasing it. The video output will be restored to the standard setting, and a picture will once again be visible on a conventional analogue TV or monitor.

### TV OUTPUT SELECT

Set the player's TV Output Select options according to the TV connection type.

**YPbPr:** When your TV is connected with the COMPONENT VIDEO OUT/PROGRESSIVE SCAN jacks on the DVD player.

**RGB:** When your TV is connected with the SCART (RGB signal) jack.

### AUDIO

Each DVD disc has a variety of audio output options. Set the player's AUDIO options according to the type of audio system you use.

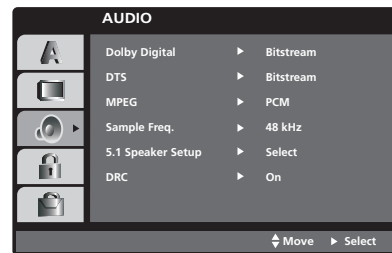

#### DOLBY DIGITAL / DTS / MPEG **DVD** **DivX**

**BITSTREAM:** Select "Bitstream" if you connect the DVD Player's DIGITAL OUT jack to an amplifier or other equipment with a Dolby Digital, DTS or MPEG decoder.

**PCM (FOR DOLBY DIGITAL / MPEG):** Select when connected to a two-channel digital stereo amplifier. DVDs encoded in Dolby Digital or MPEG will be automatically downmixed to two-channel PCM audio.

**OFF (FOR DTS):** If you select "Off", the DTS signal is not output through the DIGITAL OUT jack.

#### SAMPLE FREQ. (FREQUENCY) **DVD-V** **DVD-A**

If your receiver or amplifier is NOT capable of handling 96 kHz signals, select 48 kHz. When this choice is made, this unit automatically converts any 96 kHz signals to 48 kHz so your system can decode them.

If your receiver or amplifier is capable of handling 96 kHz signals, select 96 kHz. When this choice is made, this unit passes each type of signal through without any further processing.

Check the documentation for your amplifier to verify its capabilities.

#### 5.1 SPEAKER SETUP **DVD-V** **DVD-A** **DivX**

Select speaker settings, including volume balance and distance, or test the speaker settings.

Speaker settings are only active on the Analogue Multi-Channel Output. (See "Speaker Settings", page 28.)

### DYNAMIC RANGE CONTROL (DRC)

**DVD-V** **DVD-A** **DivX**

With the DVD format, you can hear a program's soundtrack in the most accurate and realistic presentation possible, thanks to digital audio technology. However, you may wish to compress the dynamic range of the audio output (the difference between the loudest sounds and the quietest ones). This allows you to listen to a movie at a lower volume without losing clarity of sound. Set DRC to On for this effect.

### OTHERS

The PBC, Auto Play, B.L.E. and DivX(R) VOD settings can be changed.

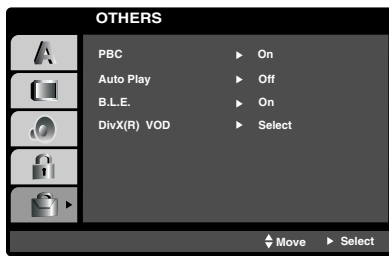

### PBC **VCD**

Set Playback Control (PBC) to On or Off.

**On:** Video CDs with PBC are played according to the PBC.

**Off:** Video CDs with PBC are played the same way as Audio CDs.

### AUTO PLAY **DVD-V**

You can set up the DVD Player so a DVD disc automatically starts playing whenever the DVD is inserted.

If Auto Play mode is set to On, this DVD player will search for the title that has the longest playback time and then play back the title automatically.

**On:** Auto Play function is active.

**Off:** Auto Play function is not active.

### NOTE

The Auto Play function may not work for some DVDs.

### B.L.E. (BLACK LEVEL EXPANSION)

To select the black level of playback pictures. Set your preference and monitor's ability.

**On:** Expanded grey scale. (0 IRE cut off)

**Off:** Standard grey scale. (7.5 IRE cut off)

### NOTE

The B.L.E. function works on NTSC systems only.

### DIVX(R) VOD **DivX**

You can show the DivX DRM (Digital Right Management) Registration code for your unit only.



The Registration code is used for VOD (Video-On- Demand) service agent. You can purchase or rent an encrypted movie file.

### NOTE

If you rent the DivX VOD file, it has several options of viewing limits as show below.

- *Displays the number of times that you can watch the file.*

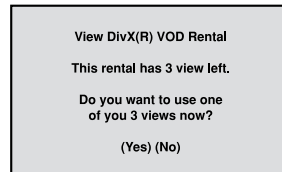

- *Shows if the rental has expired.*

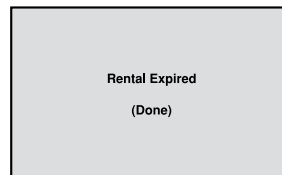

- *Displays an authorization error.*

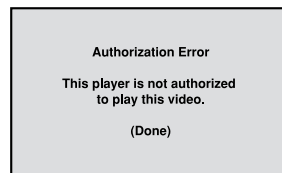

# Installation and Setup

## BEFORE OPERATION

### LOCK (PARENTAL CONTROL)

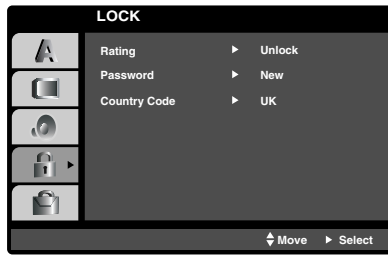

#### RATING **DVD-V**

Some movies contain scenes that may not be suitable for children to view. Many of these discs contain parental control information that applies to the complete disc or to certain scenes on the disc. Movies and scenes are rated from 1 to 8, depending on the country. Some discs offer more suitable scenes as an alternative.

The parental control feature allows you to block access to scenes below the rating you input, thereby preventing your children from being able to view material you believe is unsuitable.

- 1 Select "Rating" on the LOCK menu then press ►.
- 2 To access the Rating, Password and Country Code features, you must input the 4-digit security code you created. If you have not yet entered a security code you are prompted to do so.  
Input a 4-digit code and press ENTER. Enter it again and press ENTER to verify. If you make a mistake before pressing ENTER, press CLEAR.

- 3 Select a rating from 1 to 8 using the ▲/▼ buttons.

##### Rating 1-8

Rating one (1) has the most restrictions and rating eight (8) is the least restrictive

##### Unlock

If you select unlock, parental control is not active and the disc plays in full.

#### NOTE

If you set a rating for the player, all disc scenes with the same rating or lower are played. Higher rated scenes are not played unless an alternate scene is available on the disc. The alternative must have a lower rating. If no suitable alternative is found, playback stops. You must enter the 4-digit password or change the rating level in order to play the disc.

- 4 Press ENTER to confirm your rating selection, then press SETUP to exit the menu.

#### PASSWORD (SECURITY CODE)

You can enter or change password.

- 1 Select Password on the LOCK menu then press ►.
- 2 Follow step 2 as shown left (Rating). "Change" or "New" is highlighted.
- 3 Enter the new 4-digit code, then press ENTER. Input it again to verify.
- 4 Press SETUP to exit the menu.

*If you forget your Security Code*

If you forget your security code you can clear it using the following steps:

- 1 Press SETUP to display the Setup menu.
- 2 Input the 6-digit number "210499" and the security code is cleared.
- 3 Enter a new code as described above.

#### COUNTRY CODE **DVD-V**

Enter the code of the country/area whose standards were used to rate the DVD video disc, based on the list in the reference chapter.

- 1 Select "Country Code" on the LOCK menu then press ►.
- 2 Follow step 2 as shown in the left column (Rating).
- 3 Select the first character using ▲/▼ buttons.
- 4 Press ENTER and select the second character using ▲/▼ buttons.
- 5 Press ENTER to confirm your country code selection.



**PLAYING A DVD OR VIDEO CD**

**PLAYBACK SETUP**

You can enter or change password.

- 1 Turn on the TV and select the video input source connected to the DVD player.
- 2 Turn on the audio system (if applicable) and select the input source connected to the DVD player.
- 3 Press OPEN/CLOSE to open the disc tray and load your chosen disc in the tray, with the playback side down.
- 4 Press OPEN/CLOSE to close the tray. Playback starts automatically. If playback does not start, press PLAY.

In some cases, the disc menu might appear instead:

**DVD-V**

Use the ▲/▼/◀/▶ buttons to select the title/chapter you want to view, then press ENTER to start.  
Press TITLE or DVD MENU to return to the menu screen.

**DVD-A**

Use the ▲/▼/◀/▶ buttons to select an option you want, then press ENTER to view the option.

**VCD**

Use the number buttons to select the track you want to view and press RETURN to return to the menu screen. Menu settings and operating procedures may differ. Follow the instructions on the each menu screen. You also may set PBC to Off (See "PBC" on page 15).

**NOTES**

- If parental control is set and the disc is not within the rating settings you must input the password. (See "Lock Menu" on page 16.)
- DVDs may have a region code. Your player will not play discs that have a region code different from your player. The region code for this player is 2 (two).

**GENERAL FEATURES**

**NOTES**

Unless stated otherwise, all operations described use the remote control. Some features may also be available on the Setup menu.

**MOVING TO ANOTHER TITLE/GROUP** **DVD-V** **DVD-A**

When a disc has more than one title/group, you can move to another title/group. Press DISPLAY while playback is stopped then the appropriate number (0-9) or use ◀/▶ to move to another title/group. You can play any title by inputting its number while playback is stopped.

**MOVING TO ANOTHER CHAPTER/TRACK**

**DVD-V** **DVD-A** **VCD** **DivX**

When a title on a disc has more than one chapter or a disc has more than one track, you can move to another chapter/track as follows:

- Press SKIP ◀◀ or ▶▶ briefly during playback to select the next chapter/track or to return to the beginning of the current chapter/track.
- Press SKIP ◀◀ twice briefly to step back to the previous chapter/track.
- To go directly to any chapter during DVD playback, press DISPLAY and press ▲/▼ to select the chapter/track icon. Then, input the chapter/track number or use ◀/▶.

**SEARCH** **DVD-V** **DVD-A** **VCD** **DivX**

- 1 Press SCAN (◀◀ or ▶▶) during playback..
- 2 Press SCAN (◀◀ or ▶▶) repeatedly to select the required speed.  
DVD, DivX disc; X2, X4, X16 or X100  
Video CD; X2, X4 or X8
- 3 To exit SEARCH mode, press PLAY.

**NOTE**

When using a DVD audio disc that includes pictures, this operation may be permitted in some picture segments.

**CHANGING THE AUDIO CHANNEL** **VCD**

Press AUDIO repeatedly during playback to hear a different audio channel (Stereo, Left, or Right).

## Operation

### OPERATION WITH DVD AND VIDEO CD

#### STILL PICTURE AND FRAME-BY-FRAME PLAYBACK

**DVD-V** **DVD-A** **VCD** **DivX**

- 1 Press PAUSE/STEP on the remote control during playback. Advance the picture frame-by-frame by pressing PAUSE/STEP repeatedly.
- 2 To exit still motion mode, press PLAY.

#### NOTE

When using a DVD audio disc that includes pictures, this operation may be permitted in some picture segments.

#### SLOW MOTION **DVD-V** **DVD-A** **VCD** **DivX**

- 1 Press PAUSE/STEP (II) during playback.  
The DVD player will now go into PAUSE mode.
- 2 Use the SCAN (◀◀ or ▶▶) to select the required speed: ◀◀ 1/16, ◀◀ 1/8, ◀◀ 1/4, or ◀◀ 1/2 (backward), or ▶▶ 1/16, ▶▶ 1/8, ▶▶ 1/4, or ▶▶ 1/2 (forward).  
With a DivX Disc and Video CD, the Slow speed changes: ▶▶ 1/16, ▶▶ 1/8, ▶▶ 1/4 or ▶▶ 1/2 (forward).
- 3 To exit Slow Motion mode, press PLAY (▶).

#### NOTES

- Slow motion playback in reverse is not possible with Video CDs and DivX Discs.
- When using a DVD audio disc that includes pictures, this operation may be permitted in some picture segments.

#### RANDOM **VCD** **Karaoke DVD**

- 1 Press RANDOM during playback. The unit automatically begins random playback and RANDOM appears on the TV screen.
- 2 Press RANDOM again to return to normal.

#### TIP

By pressing SKIP (▶▶) during random playback, the unit selects another title (track) and resumes random playback.

#### NOTE

On a Video CD with PBC, You must set PBC to Off on the setup menu to use the random function (See "PBC" on page 15).

#### REPEAT A-B **DVD-V** **DVD-A** **VCD** **DivX**

To repeat a sequence.

- 1 Press A-B at your chosen starting point. "A \* " appears briefly on the TV screen.
- 2 Press A-B again at your chosen end point. "A B" appears briefly on the TV screen and the repeat sequence begins.
- 3 Press A-B again to cancel.

#### REPEAT **DVD-V** **DVD-A** **VCD** **DivX**

You can play a title/chapter/all/track/group on a disc. Press REPEAT during playback to select a desired repeat mode.

#### DVD VIDEO DISCS - REPEAT CHAPTER/TITLE/OFF

- 1 Chapter: repeats the current chapter.
- 2 Title: repeats the current title.
- 3 Off: does not play repeatedly.

#### VIDEO CDS, DIVX DISCS - REPEAT TRACK/ALL/OFF

- 1 Track: repeats the current track
- 2 All: repeats all the tracks on a disc.
- 3 Off: does not play repeatedly.

#### DVD AUDIO DISCS - REPEAT TRACK/GROUP/OFF

- 1 Track: repeats the current track.
- 2 Group: repeats the current Group.
- 3 Off: does not play repeatedly.

#### NOTES

- On a Video CD with PBC, you must set PBC to Off on the setup menu to use the repeat function (See "PBC" on page 15).
- If you press SKIP (▶▶) once during Repeat Chapter (Track) playback, the repeat playback cancels.

#### 3D SURROUND **DVD-V** **VCD** **DivX**

To produce a 3D surround effect that simulates multi-channel audio from two stereo speakers (instead of the five+ speakers normally required for multi-channel audio from a home theatre system).

- 1 Press DISPLAY during playback.
- 2 Use ▲/▼ to select the sound option.  
The sound option will be highlighted.
- 3 Use ◀/▶ to select "3D SUR".  
To turn off the 3D Surround effect, select "Normal".

#### TIME SEARCH **DVD-V** **VCD** **DivX**

To start playing at any chosen time on the disc:

- 1 Press DISPLAY during playback. The time search box shows the elapsed playing time.
- 2 Press ▲/▼ to select the time clock icon and "--:--" appears.
- 3 Input the required start time in hours, minutes, and seconds from left to right. If you enter the wrong numbers, press CLEAR to remove the numbers you entered. Then input the correct numbers.
- 4 Press ENTER to confirm. Playback starts from the selected time.

**ZOOM** DVD-V DVD-A VCD DivX

Use zoom to enlarge the video image.

- 1 Press ZOOM during playback or still playback to activate the Zoom function. The square frame appears briefly in the right bottom of the picture.
- 2 Each press of the ZOOM button changes the TV screen in the sequence: 100% size → 400% size → 1600% size → screen fit mode → 100% size  
Screen fit mode:  
You can change the way the image appears on the screen when you're playing a DVD movie. Press ▲/▼ to select between Normal, Enhanced, and Maximum.
- 3 Use the ▲/▼/◀/▶ buttons to move through the zoomed picture.
- 4 To resume normal playback, press CLEAR.

**NOTES**

- Zoom may not work on some DVDs.
- Screen fit mode is available for playing the DVD disc, VR disc and movie file.

**MARKER SEARCH** DVD-V VCD DivX

**To enter a Marker**

You can start playback from up to nine memorized points. To enter a marker, press MARKER at the desired point on the disc. The Marker icon appears on the TV screen briefly. Repeat to enter up to nine markers.

**To Recall or Clear a Marked Scene**

- 1 During disc playback, press SEARCH. The marker search menu appears on the screen.
- 2 Within 10 seconds, press ◀/▶ to select a marker number that you want to recall or clear.
- 3 Press ENTER and playback starts from the marked scene. Or, Press CLEAR and the marker number is erased from the list.
- 4 You can play any marker by inputting its number on the marker search menu.

**PAUSE** DVD-V DVD-A VCD DivX

- 1 Press PAUSE/STEP during playback.
- 2 To return to playback, press PLAY.

**SPECIAL DVD FEATURES**

**CHECKING THE CONTENTS OF DVD DISCS: MENUS**

DVDs may offer menus that allow you to access special features. To use the disc menu, press DVD MENU. Input the corresponding number or use the ▲/▼/◀/▶ buttons to highlight your selection. Then press ENTER.

**TITLE MENU** DVD-V DVD-A

- 1 Press TITLE. If the current title has a menu, the menu appears on the screen. Otherwise, the disc menu may appear.
- 2 The menu offers features such as camera angles, spoken language and subtitle options, and chapters for the title.
- 3 Press TITLE to exit.

**DISC MENU** DVD-V DVD-A

- 1 Press DVD MENU and the disc menu is displayed.
- 2 Press DVD MENU again to exit.

**CAMERA ANGLE** DVD-V DVD-A

If the disc contains scenes recorded at different camera angles, you can change to a different camera angle during playback. Press ANGLE repeatedly during playback to select a desired angle. Note that the number of the current angle appears on the display.

**TIP**

*The angle indicator will blink on the TV screen during scenes recorded at different angles as an indication that angle switching is possible.*

**CHANGING THE AUDIO LANGUAGE**

DVD-V DVD-A DivX

Press AUDIO repeatedly during playback to hear a different audio language or audio track.

With DVD-RW discs recorded in VR mode that have both a main and a Bilingual audio channel, you can switch between Main (L), Bilingual (R), or a mix of both (Main + Bilingual) by pressing AUDIO.

**SUBTITLES** DVD-V DivX

Press SUBTITLE repeatedly during playback to see the different subtitle languages.

**NOTES**

- The subtitle file of the DivX file is displayed only in smi, srt and sub.
- If there is no information or there is a code that cannot be read in the DivX file, "1" etc., is displayed.

# Operation

## OPERATION WITH DVD AND VIDEO CD

### DVD AUDIO DISCS

DVD Audio is a new disc format building on the success of DVD to provide high quality, uncompressed, multi-channel audio for a new experience in audio quality. A DVD Audio disc can be identified by the DVD audio logo on the disc jacket or on the disc itself.

DVD Audio can provide higher quality stereo than Audio CDs with a sampling rate of up to 192 kHz (compared to 44.1 kHz for CDs). DVD Audio digital sound can be delivered with up to 24 bits of data (compared to 16 bits for a standard CD).

A typical DVD Audio disc contains up to seven times the data capacity of a CD. This additional space is used for music, either Advanced Resolution multi-channel sound quality that is closer to the artist's master recording or for longer recordings. Many DVD Audio discs contain on-screen text, such as artist biographies, playlists, or lyrics. Some DVD Audio discs contain photo galleries or video clips.

#### NOTE

*To enjoy maximum sound quality and surround effect of DVD Audio, you must use 5.1 channel analogue audio output (5.1CH AUDIO OUT jacks on the DVD Player). If you use the DIGITAL OUT (OPTICAL or COAXIAL) for your audio connection, the sound will only be similar to CD-quality sound even though you're playing a DVD Audio disc.*

### MOVING TO ANOTHER GROUP

Some DVD Audio discs divide content into different groups. Your player enables you to quickly access different groups during playback via the on-screen display.

- 1 Press DISPLAY during playback on in stop mode.
- 2 Press ▲/▼ to select Group icon.
- 3 Press ◀/▶ or the numbered buttons (0-9) to select a group number.



#### NOTE

*Sometimes the author of the disc creates hidden content that can only be accessed by entering a password. If the lock icon appears on the TV screen, enter the password (sometimes you'll find it on the disc's jacket cover or on a web site). This password control isn't dictated by your DVD Player — it is a function of the disc. Since the authoring of DVD Audio Discs varies, some of the on-screen display choices might not be available for the disc you're playing.*

### VIEWING ANOTHER PAGE

Since DVD Audio discs can hold a lot of content, there are various ways to see what's available on the disc.

- 1 Press DISPLAY during playback.
- 2 Press ▲/▼ to select Page icon.
- 3 Press ◀/▶ to select a page number.

What appears on the screen will vary from disc to disc because the information available depends upon the way the disc was created.

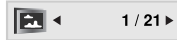

#### NOTE

*Since the authoring of DVD Audio Discs varies, some of the on-screen display choices might not be available for the disc you're playing.*

**PLAYING AN AUDIO CD OR MP3/WMA DISC**

The DVD player can play MP3/WMA formatted recordings on CD-ROM, CD-R, or CD-RW discs.

**AUDIO CD**

Once you insert an audio CD a menu appears on the TV screen. Press ▲/▼ to select a track then press PLAY or ENTER and playback starts.



**MP3 / WMA**

- 1 Press ▲/▼ to select a folder, and press ENTER to see the folder contents.
- 2 Press ▲/▼ to select a track then press PLAY or ENTER. Playback starts.

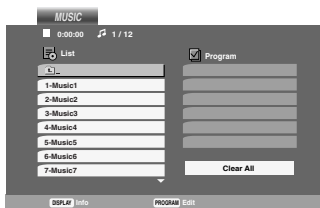

**ID3 TAG**

- When playing a file containing information such as track titles, you can see the information by pressing DISPLAY.  
[ Title, Artist, Album, Year, Comment ]
- If there is no information, "NO ID3 TAG" appear on the display.

**TIP**

- If you are in a file list on the MUSIC menu and want to return to the Folder list, use the ▲/▼ to highlight [L] and press ENTER.
- Press DVD MENU to move to the next page.
- On a CD with MP3/WMA and JPEG, you can switch between MP3/WMA and JPEG. Press TITLE and MUSIC or PHOTO at the top of the menu is highlighted.

**MP3 / WMA disc compatibility with this player is limited as follows:**

- 1 Sampling frequency: within 8 - 48 kHz (MP3), within 32 - 48 kHz (WMA)
- 2 Bit rate: within 8 - 320kbps (MP3), 32 - 192kbps (WMA)
- 3 The player cannot read an MP3/WMA file that has a file extension other than ".mp3" / ".wma".
- 4 CD-R physical format should be ISO 9660
- 5 If you record MP3 / WMA files using software that cannot create a file system (eg. Direct-CD) it is impossible to playback MP3 / WMA files. We recommend that you use Easy-CD Creator, which creates an ISO 9660 file system.
- 6 File names should have a maximum of 8 letters and must incorporate an .mp3 or .wma extension.
- 7 They should not contain special letters such as / ? \* : " < > | etc.
- 8 The total number of files on the disc should be less than 650.

This DVD player requires discs and recordings to meet certain technical standards in order to achieve optimal playback quality. Pre-recorded DVDs are automatically set to these standards. There are many different types of recordable disc formats (including CD-R containing MP3 or WMA files) and these require certain pre-existing conditions (see above) to ensure compatible playback.

**Customers should note that permission is required in order to download MP3 / WMA files and music from the Internet. NAD ELECTRONICS INTERNATIONAL has no right to grant such permission. Permission should always be sought from the copyright owner.**

## Operation

### OPERATION WITH AUDIO CD AND MP3 / WMA DISC

#### AUDIO CD AND MP3 / WMA DISC FEATURES

##### PAUSE **CD** **MP3** **WMA**

- 1 Press PAUSE/STEP during playback.
- 2 To return to playback, press PLAY, ENTER or press PAUSE/STEP again.

##### MOVING TO ANOTHER TRACK **CD** **MP3** **WMA**

- 1 Press SKIP (◀◀ or ▶▶) briefly during playback to go to the next track or to return to the beginning of the current track.
- 2 Press SKIP ◀◀ twice briefly to go back to the previous track.
- 3 You can play any track by inputting its number.

##### REPEAT TRACK/ALL/OFF **CD** **MP3** **WMA**

You can play a track/all on a disc.

- 1 Press REPEAT when playing a disc. The repeat icon appears.
- 2 Press REPEAT to select a desired repeat mode.  
Track: repeats the current track  
All: repeats all the tracks on a disc.  
Off(No display): does not play repeatedly.

##### NOTE

*If you press SKIP (▶▶) once during Repeat Track playback, the repeat playback cancels.*

##### SEARCH **CD** **MP3** **WMA**

- 1 Press SCAN (◀◀ or ▶▶) during playback.
- 2 Press SCAN (◀◀ or ▶▶) repeatedly to select the required speed: X2, X4, X8 backward or forward.
- 3 To exit SEARCH mode, press PLAY.

##### RANDOM **CD** **MP3** **WMA**

- 1 Press RANDOM during playback. Random Playback begins immediately and RANDOM appears on the menu screen.
- 2 To return to normal playback, press RANDOM repeatedly until RANDOM disappears from the menu screen.

##### TIP

*By pressing SKIP: ▶▶ during random playback, the unit selects another track and resumes random playback.*

##### REPEAT A-B **CD**

- 1 To repeat a sequence during disc playback press A-B at your chosen starting point. The Repeat icon and "A" appear on the menu screen.
- 2 Press A-B again at your chosen end point. The Repeat icon and "A-B" appear on the menu screen, and the sequence begins to play repeatedly.
- 3 To exit the sequence and return to normal play, press A-B again. The Repeat icon disappears from the menu screen.

##### 3D SURROUND **CD**

To produce a 3D surround effect that simulates multi-channel audio from two stereo speakers (instead of the five+ speakers normally required for multi-channel audio from a home theatre system).

- 1 Press AUDIO during playback.  
"3D SUR." appears on the menu screen.
- 2 To return to normal playback, press AUDIO repeatedly until "3D SUR." disappears from the menu screen.

The program function enables you to store your favourite tracks from any disc in the player memory. A program can contain 30 tracks.

- 1 Insert a disc.  
**Audio CD or MP3/WMA Discs:**  
 AUDIO CD or MUSIC menu appears.
- 2 Press PROGRAM.  
 The  mark will appear to the right of the word "Program" on the right side of the menu screen.

**NOTE**

Press PROGRAM again, then the  mark will disappear to exit the Program Edit mode.

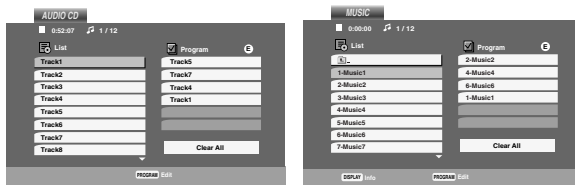

Audio CD Menu

MP3/WMA Menu

**VIDEO CD**

Press PROGRAM while playback is stopped. The program menu appears. Press PROGRAM again and hold it down for a few seconds to exit the menu.

**NOTE**

On a Video CD with PBC, you must set PBC to Off on the setup menu to use the programmed playback (See "PBC" on page 15).

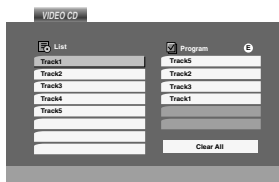

Video CD Menu

- 3 Select a track on the "List", then press ENTER to place the selected track on the "Program" list. Repeat to place additional tracks on the list.
- 4 Press .  
 Select the track you want to start playing on the "Program" list.

- 5 Press PLAY or ENTER to start. Playback begins in the order in which you programmed the tracks. Playback stops after all of the tracks on the "Program" list have played once.
- 6 To resume normal playback from programmed playback, select a track of AUDIO CD (or MUSIC) list and then press PLAY.



**REPEAT PROGRAMMED TRACKS**

- 1 Press REPEAT when playing a disc. The repeat icon appears.
- 2 Press REPEAT to select a desired repeat mode.  
 Track: repeats the current track  
 All: repeats all the tracks on the programmed list.  
 Off (No display): does not play repeatedly.



**NOTE**

If you press  once during Repeat Track playback, the repeat playback cancels.

**ERASING A TRACK FROM PROGRAM LIST**

- 1 Use /  to select the track that you wish to erase from the Program list.
- 2 Press CLEAR. Repeat to erase additional tracks on the list.

**ERASING THE COMPLETE PROGRAM LIST**

- 1 Press  to move to the "Program" list.
- 2 Use / to select "Clear All", then press ENTER.

**NOTE**

The programs are also cleared when the disc is removed.

# Operation

## OPERATION WITH JPEG DISC

### VIEWING A JPEG DISC

Using this DVD Player you can view Kodak PICTURE CDs and discs with JPEG files.

- 1 Insert a disc and close the tray. The PHOTO menu appears on the TV screen.

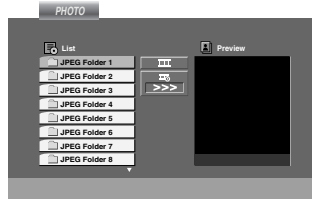

- 2 Press ▲/▼ to select a folder, and press ENTER. A list of files in the folder appears. If you are in a file list and want to return to the previous Folder list, use the ▲/▼ buttons on the remote to highlight and press ENTER.
- 3 If you want to view a particular file, press ▲/▼ to highlight a file and press ENTER or PLAY. Viewing the file proceeding starts. While viewing a file, you can press STOP to move to the previous menu (PHOTO menu).

#### TIP

- Press DVD MENU to move to the next page.
- There are three Slide Speed options : >>> (Fast), >> (Normal), and > (Slow). Use ▲/▼/◀/▶ to highlight the Speed. Then, use ◀/▶ to select the option you want to use then press ENTER.
- On a disc with MP3/WMA and JPEG, you can switch between MP3/WMA and JPEG. Press TITLE and MUSIC or PHOTO at the top of the menu is highlighted.
- Press RETURN, file information is hidden.

### SLIDE SHOW **JPEG**

Use ▲/▼/◀/▶ to highlight the (Slide Show) then press ENTER.

### STILL PICTURE **JPEG**

- 1 Press PAUSE/STEP during slide show. The player will now go into PAUSE mode.
- 2 To return to the slide show, press PLAY or press PAUSE/STEP again.

### MOVING TO ANOTHER FILE **JPEG**

Press SKIP ( or ) or cursor (/▶) once while viewing a picture to advance to the next or previous file.

### ZOOM **JPEG**

Use zoom to enlarge the photo image. (see page 19)

### TO ROTATE PICTURE **JPEG**

Press ▲/▼ during showing a picture to rotate the picture clockwise or counter clockwise.

### TO LISTEN TO MP3/WMA MUSIC WATCHING PICTURE **JPEG**

You can display files while listening to MP3/WMA music files recorded on the same disc.

- 1 Insert the disc containing the two types of files in the player.
- 2 Press TITLE to display PHOTO menu.
- 3 Press ▲/▼ to select a photo file.
- 4 Use ▶ to select icon then press ENTER. Playback starts. The playback will continue until STOP is pressed.

#### TIP

To listen to only the desired music watching picture, programmed the desired tracks from the "MUSIC" menu and then proceed as above.

### JPEG DISC COMPATIBILITY WITH THIS PLAYER IS LIMITED AS FOLLOWS:

- Depending upon the size and number of JPEG files, it could take a long time for the DVD player to read the disc's contents. If you don't see an on- screen display after several minutes, some of the files may be too large — reduce the resolution of the JPEG files to less than 2M pixels as 2760 x 2048 pixels and burn another disc.
- The total number of files and folders on the disc should be less than 650.
- Some discs may be incompatible due to a different recording format or the condition of the disc.
- Ensure that all the selected files have the ".jpg" extensions when copying into the CD layout.
- If the files have ".jpe" or ".jpeg" extensions, please rename them as ".jpg" files.
- File names without a ".jpg" extension will not be able to be read by this DVD player even though the files are shown as JPEG image files in Windows Explorer.



This unit will play DVD-R/RW discs recorded using the DVD-Video format that have been finalized using a DVD-recorder.

- This unit will play DVD-RW discs recorded using the Video Recording (VR) format.
- 1 Insert a disc and close the tray. The DVD-VR menu appears on the TV screen.

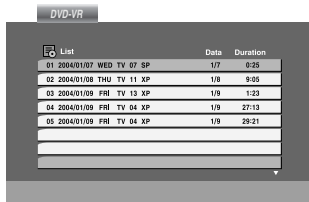

- 2 Press ▲/▼ to select a track then press PLAY or ENTER and playback starts.

### NOTES

- *Unfinalized DVD-R/RW discs cannot be played in this player.*
- *Some DVD-VR disc are made with CPRM data by DVD RECORDER. Player does not support these kinds of discs and display the "CHECK DISC".*

### WHAT IS 'CPRM'?

CPRM is a copy protection system (with scramble system) only allowing the recording of 'copy once' broadcast programs. CPRM stands for Content Protection for Recordable Media.

This player is CPRM compatible, which means that you can record copy-once broadcast programs, but you cannot then make a copy of those recordings. CPRM recordings can only be made on DVD-RW discs formatted in VR mode, and CPRM recordings can only be played on players that are specifically compatible with CPRM.

### MAINTENANCE AND SERVICE

Refer to the information in this chapter before contacting a service technician.

### HANDLING THE UNIT

#### When shipping the unit

Please save the original shipping carton and packing materials. If you need to ship the unit, for maximum protection, re-pack the unit as it was originally packed at the factory.

#### Keeping the exterior surfaces clean

- *Do not use volatile liquids such as insecticide spray near the unit.*
- *Do not leave rubber or plastic products in contact with the unit for a long period of time. since they leave marks on the surface.*

#### Cleaning the unit

To clean the player, use a soft, dry cloth. If the surfaces are extremely dirty, use a soft cloth lightly moistened with a mild detergent solution.

Do not use strong solvents such as alcohol, benzene, or thinner, as these might damage the surface of the unit.

#### Maintaining the Unit

The DVD player is a high-tech, precision device. If the optical pick-up lens and disc drive parts are dirty or worn, the picture quality could be diminished.

Depending on the operating environment, regular inspection and maintenance are recommended after every 1,000 hours of use.

For details, please contact your nearest authorized service centre.

## Operation

### OPERATION WITH A DIVX MOVIE DISC

Using this DVD Player you can play DivX discs.

- 1 Insert a disc and close the tray. The MOVIE menu appears on the TV screen.

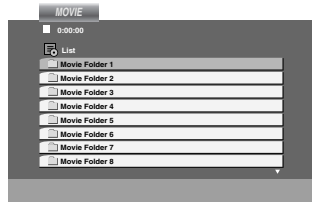

- 2 Press ▲/▼ to select a folder, and press ENTER. A list of files in the folder appears. If you are in a file list and want to return to the Folder list, use the ▲/▼ buttons on the remote to highlight  and press ENTER.
- 3 If you want to view a particular file, press ▲/▼ to highlight a file and press ENTER or PLAY.
- 4 Press STOP to exit.

#### TIP

- Press DVD MENU to move to the next page.
- On a CD with MP3/WMA, JPEG and MOVIE files, you can switch to the MUSIC, PHOTO and MOVIE menu. Press TITLE and MUSIC, PHOTO and MOVIE at the top of the menu is highlighted.

#### DIVX DISC COMPATIBILITY WITH THIS PLAYER IS LIMITED AS FOLLOWS:

- Available resolution size of the DivX file is under 720x576 (W x H) pixels.
- The file name of the DivX subtitle is available up to 56 characters.
- If there is an impossible code to express the DivX file, it may be displayed as " \_ " mark on the display.
- **If the number of screen frames is over 30 per 1 second, this unit may not operate normally.**
- **If the video and audio structure of the recorded file is not interleaved video, audio or both may not be outputted.**
- **If the file is recorded with GMC, the unit supports only 1-point of the record level.**

\* GMC?

GMC is the acronym for Global Motion Compensation. It is an encoding tool specified in MPEG4 standard. Some MPEG4 encoders, like DivX or Xvid, have this option. There are different levels of GMC encoding, usually called 1-point, 2-point, or 3-point GMC.

#### Playable DivX files

- ".avi ", ".mpg ", ".mpeg "

#### Playable Codec formats

- "DIVX3.xx ", "DIVX4.xx ", "DIVX5.xx ", "XVID ", "MP43 ", "3IX "

#### Playable Audio format

- "AC3 ", "DTS ", "PCM ", "MP3 ", "WMA "
- Sampling frequency: within 8 - 48 kHz (MP3), within 32 - 48 kHz (WMA)
- Bit rate: within 8 - 320kbps (MP3), 32 - 192kbps (WMA)

## ADDITIONAL FEATURES

## LAST SCENE MEMORY

**DVD-V** **DVD-A** **CD** **VCD**

This player memorizes the last scene from the last disc that is viewed. The last scene remains in memory even if you remove the disc from the player or switch off the player. If you load a disc that has the scene memorized, the scene is automatically recalled.

## NOTE

*This player does not memorize the scene of a disc if you switch off the player before commencing to play the disc.*

## SCREEN SAVER

The screen saver appears when you leave the DVD player in Stop mode for about five minutes. If the Screen Saver is displayed for five minutes, the DVD Player automatically turns itself off.

## VIDEO MODE SETTING

- With certain discs, the playback picture may be flickering or Dot Crawl is shown on straight lines. That means Vertical interpolation or De-interlace is not perfectly matched with the disc. In this case, the picture quality may be improved by changing the video mode.
- To change the video mode, press and hold DISPLAY about 3 seconds during disc playback. The new video mode number selected is displayed on the TV screen. Check whether the video quality has improved. If not, repeat the above procedure until picture quality is improved.
- Video mode change sequence:  
MODE1 → MODE2 → MODE3 → MODE1
- If you turn off the power, the video mode will be back to initial state (MODE1).

## TIP

## DETAILED DESCRIPTIONS FOR VIDEO MODES

**MODE1:** The source material of the DVD video (film material or video material) is determined from disc information.

**MODE2:** Suitable for playing film based content or video based material recorded by the progressive scan method.

**MODE3:** Suitable for playing video based content with comparatively little motion.

## NOTE

*The video mode setting only works when the Progressive Scan mode is set to "On" in the Setup menu.*

## SYSTEM SELECT

You must select the appropriate system mode for your TV system. If NO DISC appears in the display window, press and hold PAUSE on the front panel for more than 5 seconds to be able to select a system (PAL, NTSC, or AUTO).

# Operation

## SPEAKER SETUP

This chapter includes important reference information to help you set your DVD player.

### SPEAKER SETUP

Make the following settings for the built-in 5.1 channel surround decoder.

- 1 Press SETUP. The setup menu appears.

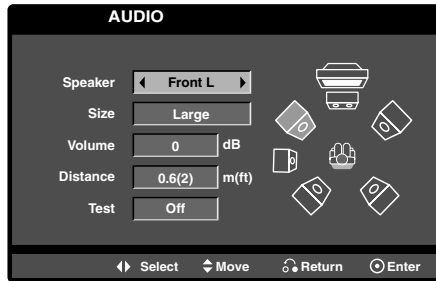

- 2 Use ▲/▼ to select the AUDIO option then press 4 to move to the second level.
- 3 Use ▲/▼ to select the Speaker Setup option then press ► to move to the third level. "Select" is highlighted.
- 4 Press ENTER and the 5.1 Speaker Setup menu appears.
- 5 Use ◀/▶ to select the desired speaker.
- 6 Adjust options using ▲/▼/◀/▶ buttons.
- 7 Press ENTER to confirm your selection. Returns to the previous menu.

### SPEAKER SELECTION

Select a speaker that you want to adjust. (Front speakers (Left), Centre Speaker, Front speakers (Right), Rear speakers (Right), Rear speakers (Left), or SubWoofer).

### SIZE

Press ◀/▶ to set a mode. (Large, Small or None)

If you have connected the system to a speaker with a low frequency of 100 Hz or below, select "Large."

If you have connected the system to a speaker without a low frequency of 100 Hz or below, select "Small." If you have not connected a subwoofer, always select "Large" for Front speakers (L/R).

When you do not have a certain speaker connected, select "None."

Front L/R speaker's size can be set to "Large" or "Small."

If Front L/R speaker's size is set to "Small," Rear and Centre speaker's size can be set to "Small" or "None."

Subwoofer's size can be set only to "Large" or "None".

### VOLUME

Press ◀/▶ to adjust the output level of the selected speaker. (-10dB - 0dB)

### DISTANCE

If you connected speakers to your DVD Player, setting the Distance lets the speakers know how far the sound has to travel to reach your set listening point. This allows the sound from each speaker to reach the listener at the same time.

Press ◀/▶ to adjust the Distance of the selected speaker. [0.3(1)m(ft) - 6.0(20)m(ft)]

### TEST

Press ◀/▶ to test the signals of each speaker. Adjust the volume to match the volume of test signals memorized in the system.

Front Left (L) → Center → Front Right (R)  
→ Rear Left (R) → Rear Right (L) → SubWoofer

You can adjust the volume during operating the test tone, first use ▲/▼ buttons to select Volume or Speaker option, then use the ◀/▶ buttons to select volume or speaker, so that the volume of all speakers is the same from the listener's position.

If you adjust the volume while operating the test tone, the test tone will be held paused in the current speaker channel.

Check the following guide for the possible cause of a problem before contacting service.

SYMPTOM	CAUSE	CORRECTION
<b>No power.</b>	<ul style="list-style-type: none"> <li>The power cord is disconnected.</li> </ul>	<ul style="list-style-type: none"> <li>Plug the power cord securely into the mains socket.</li> </ul>
<b>The power is on, but the DVD player does not work.</b>	<ul style="list-style-type: none"> <li>No disc is inserted.</li> </ul>	<ul style="list-style-type: none"> <li>Insert a disc. (Check that the DVD or, audio CD indicator in the display window is lit.)</li> </ul>
<b>No picture.</b>	<ul style="list-style-type: none"> <li>The TV is not set to receive DVD signal output.</li> </ul>	<ul style="list-style-type: none"> <li>Select the appropriate video input mode on the TV.</li> </ul>
	<ul style="list-style-type: none"> <li>The video cable is not connected securely.</li> </ul>	<ul style="list-style-type: none"> <li>Connect the video cable securely.</li> </ul>
<b>No sound.</b>	<ul style="list-style-type: none"> <li>The equipment connected with the audio cable is not set to receive DVD signal output.</li> </ul>	<ul style="list-style-type: none"> <li>Select the correct input mode of the audio receiver so you can listen to the sound from the DVD player.</li> </ul>
	<ul style="list-style-type: none"> <li>The power of the equipment connected with the audio cable is turned off.</li> </ul>	<ul style="list-style-type: none"> <li>Turn on the equipment connected with the audio cable.</li> </ul>
	<ul style="list-style-type: none"> <li>The AUDIO options are set to the wrong position.</li> </ul>	<ul style="list-style-type: none"> <li>Set the Digital Audio Output to the correct position, then turn on the DVD player again by pressing POWER.</li> </ul>
<b>The DVD player does not start playback.</b>	<ul style="list-style-type: none"> <li>An unplayable disc is inserted.</li> </ul>	<ul style="list-style-type: none"> <li>Insert a playable disc. (Check the disc type, color system, and regional code.)</li> </ul>
	<ul style="list-style-type: none"> <li>The rating level is set.</li> </ul>	<ul style="list-style-type: none"> <li>Cancel the rating function or change the rating level.</li> </ul>
<b>The remote control does not work properly.</b>	<ul style="list-style-type: none"> <li>The remote control is not pointed at the remote sensor on the DVD player.</li> </ul>	<ul style="list-style-type: none"> <li>Point the remote control at the remote sensor of the DVD player.</li> </ul>
	<ul style="list-style-type: none"> <li>The remote control is too far from the DVD player.</li> </ul>	<ul style="list-style-type: none"> <li>Operate the remote control closer to the DVD player.</li> </ul>

## Reference

### TABLE OF LANGUAGES AND THEIR CODES

Language Code List

Use this list to input your desired language for the following initial settings: Disc Audio, Disc Subtitle, Disc Menu.

Code	Language	Code	Language	Code	Language	Code	Language
6566	Abkhazian	7074	Fiji	7678	Lingala	8373	Singhalese
6565	Afar	7073	Finnish	7684	Lithuanian	8375	Slovak
6570	Afrikaans	7082	French	7775	Macedonian	8376	Slovenian
8381	Albanian	7089	Frisian	7771	Malagasy	8379	Somali
6577	Ameharic	7176	Galician	7783	Malay	6983	Spanish
6582	Arabic	7565	Georgian	7776	Malayalam	8385	Sudanese
7289	Armenian	6869	German	7784	Maltese	8387	Swahili
6583	Assamese	6976	Greek	7773	Maori	8386	Swedish
6588	Aymara	7576	Greenlandic	7782	Marathi	8476	Tagalog
6590	Azerbaijani	7178	Guarani	7779	Moldavian	8471	Tajik
6665	Bashkir	7185	Gujarati	7778	Mongolian	8465	Tamil
6985	Basque	7265	Hausa	7865	Nauru	8484	Tatar
6678	Bengali; Bangla	7387	Hebrew	7869	Nepali	8469	Telugu
6890	Bhutani	7273	Hindi	7879	Norwegian	8472	Thai
6672	Bihari	7285	Hungarian	7982	Oriya	6679	Tibetan
6682	Breton	7383	Icelandic	8065	Panjabi	8473	Tigrinya
6671	Bulgarian	7378	Indonesian	8083	Pashto, Pushto	8479	Tonga
7789	Burmese	7365	Interlingua	7065	Persian	8482	Turkish
6669	Byelorussian	7165	Irish	8076	Polish	8475	Turkmen
7577	Cambodian	7384	Italian	8084	Portuguese	8487	Twi
6765	Catalan	7465	Japanese	8185	Quechua	8575	Ukrainian
9072	Chinese	7487	Javanese	8277	Rhaeto-Romance	8582	Urdu
6779	Corsican	7578	Kannada	8279	Rumanian	8590	Uzbek
7282	Croatian	7583	Kashmiri	8285	Russian	8673	Vietnamese
6783	Czech	7575	Kazakh	8377	Samoan	8679	Volapük
6865	Danish	7589	Kirghiz	8365	Sanskrit	6789	Welsh
7876	Dutch	7579	Korean	7168	Scots Gaelic	8779	Wolof
6978	English	7585	Kurdish	8382	Serbian	8872	Xhosa
6979	Esperanto	7679	Laothian	8372	Serbo-Croatian	7473	Yiddish
6984	Estonian	7665	Latin	8378	Shona	8979	Yoruba
7079	Faroese	7686	Latvian, Lettish	8368	Sindhi	9085	Zulu

Choose a country code from this list.

Code	Country	Code	Country	Code	Country	Code	Country
AD	Andorra	ER	Eritrea	LC	Saint Lucia	SC	Seychelles
AE	United Arab Emirates	ES	Spain	LI	Liechtenstein	SD	Sudan
AF	Afghanistan	ET	Ethiopia	LK	Sri Lanka	SE	Sweden
AG	Antigua and Barbuda	FI	Finland	LR	Liberia	SG	Singapore
AI	Anguilla	FJ	Fiji	LS	Lesotho	SH	Saint Helena
AL	Albania	FK	Falkland Islands	LT	Lithuania	SI	Slovenia
AM	Armenia	FM	Micronesia	LU	Luxembourg	SJ	Svalbard and Jan Mayen
AN	Netherlands Antilles	FO	Faroe Islands	LV	Latvia Islands	SK	Slovak Republic
AO	Angola	FR	France	LY	Libya	SL	Sierra Leone
AQ	Antarctica	FX	France (European Territory)	MA	Morocco	SM	San Marino
AR	Argentina	GA	Gabon	MC	Monaco	SN	Senegal
AS	American Samoa	GB	Great Britain	MD	Moldavia	SO	Somalia
AT	Austria	GD	Grenada	MG	Madagascar	SR	Suriname
AU	Australia	GE	Georgia	MH	Marshall Islands	ST	Saint Tome and Principe
AW	Aruba	GF	French Guyana	MK	Macedonia	SU	Former USSR
AZ	Azerbaijan	GH	Ghana	ML	Mali	SV	El Salvador
BA	Bosnia-Herzegovina	GI	Gibraltar	MM	Myanmar	SY	Syria
BB	Barbados	GL	Greenland	MN	Mongolia	SZ	Swaziland
BD	Bangladesh	GM	Gambia	MO	Macau	TC	Turks and Caicos Islands
BE	Belgium	GN	Guinea	MP	Northern Mariana Islands	TD	Chad
BF	Burkina Faso	GP	Guadeloupe (French)	MQ	Martinique (French)	TF	French Southern Territories
BG	Bulgaria	GQ	Equatorial Guinea	MR	Mauritania	TG	Togo
BH	Bahrain	GR	Greece	MS	Montserrat	TH	Thailand
BI	Burundi	GS	S. Georgia & S. Sandwich Isls.	MT	Malta	TJ	Tadjikistan
BJ	Benin	GT	Guatemala	MU	Mauritius	TK	Tokelau
BM	Bermuda	GU	Guam (USA)	MV	Maldives	TM	Turkmenistan
BN	Brunei Darussalam	GW	Guinea Bissau	MW	Malawi	TN	Tunisia
BO	Bolivia	GY	Guyana	MX	Mexico	TO	Tonga
BR	Brazil	HK	Hong Kong	MY	Malaysia	TP	East Timor
BS	Bahamas	HM	Heard and McDonald Islands	MZ	Mozambique	TR	Turkey
BT	Bhutan	HN	Honduras	NA	Namibia	TT	Trinidad and Tobago
BV	Bouvet Island	HR	Croatia	NC	New Caledonia (French)	TV	Tuvalu
BW	Botswana	HT	Haiti	NE	Niger	TW	Taiwan
BY	Belarus	HU	Hungary	NF	Norfolk Island	TZ	Tanzania
BZ	Belize	ID	Indonesia	NG	Nigeria	UA	Ukraine
CA	Canada	IE	Ireland	NI	Nicaragua	UG	Uganda
CC	Cocos (Keeling) Islands	IL	Israel	NL	Netherlands	UK	United Kingdom
CF	Central African Republic	IN	India	NO	Norway	UM	USA Minor Outlying Islands
CG	Congo	IO	British Indian Ocean Territory	NP	Nepal	US	United States
CH	Switzerland	IQ	Iraq	NR	Nauru	UY	Uruguay
CI	Ivory Coast	IR	Iran	NU	Niue	UZ	Uzbekistan
CK	Cook Islands	IS	Iceland	NZ	New Zealand	VA	Vatican City State
CL	Chile	IT	Italy	OM	Oman	VC	Saint Vincent & Grenadines
CM	Cameroon	JM	Jamaica	PA	Panama	VE	Venezuela
CN	China	JO	Jordan	PE	Peru	VG	Virgin Islands (British)
CO	Colombia	JP	Japan	PF	Polynesia (French)	VI	Virgin Islands (USA)
CR	Costa Rica	KE	Kenya	PG	Papua New Guinea	VN	Vietnam
CS	Former Czechoslovakia	KG	Kyrgyzstan	PH	Philippines	VU	Vanuatu
CU	Cuba	KH	Cambodia	PK	Pakistan	WF	Wallis and Futuna Islands
CV	Cape Verde	KI	Kiribati	PL	Poland	WS	Samoa
CX	Christmas Island	KM	Comoros	PM	Saint Pierre and Miquelon	YE	Yemen
CY	Cyprus	KN	Saint Kitts & Nevis Anguilla	PN	Pitcairn Island	YT	Mayotte
CZ	Czech Republic	KP	North Korea	PR	Puerto Rico	YU	Yugoslavia
DE	Germany	KR	South Korea	PT	Portugal	ZA	South Africa
DJ	Djibouti	KW	Kuwait	PW	Palau	ZM	Zambia
DK	Denmark	KY	Cayman Islands	PY	Paraguay	ZR	Zaire
DM	Dominica	KZ	Kazakhstan	QA	Qatar	ZW	Zimbabwe
DO	Dominican Republic	LA	Laos	RE	Reunion (French)		
DZ	Algeria	LB	Lebanon	RO	Romania		
EC	Ecuador			RU	Russian Federation		
EE	Estonia			RW	Rwanda		
EG	Egypt			SA	Saudi Arabia		
EH	Western Sahara			SB	Solomon Islands		

## Reference

### SPECIFICATIONS

#### GENERAL

Power requirements	AC 110-240 V, 50/60 Hz
Power consumption	12 W
Dimensions (approx.)	430 x 39 x 242 mm (W x H x D) without foot
Weight (approx.)	2.2 kg
Operating temperature	5 °C to 35 °C (41 °F to 95 °F)
Operating humidity	5 % to 90 %

#### SYSTEM

Laser	Semiconductor laser, wavelength 650 nm
Signal system	PAL/NTSC
Frequency response	DVD (PCM 96 kHz): 8 Hz to 44 kHz DVD (PCM 48 kHz): 8 Hz to 22 kHz CD: 8 Hz to 20 kHz
Signal-to-noise ratio	More than 100 dB (ANALOG OUT connectors only)
Harmonic distortion	Less than 0.008%
Dynamic range	More than 90 dB (DVD/CD)

#### OUTPUTS

VIDEO OUT	1 Vp-p 75 $\Omega$ , sync negative, RCA jack x 1 /SCART (TO TV)
S-VIDEO OUT	(Y) 1.0 V (p-p), 75 $\Omega$ , negative sync, Mini DIN 4-pin x 1 (C) 0.3 V (p-p) 75 $\Omega$
COMPONENT VIDEO OUT	(Y) 1.0 V (p-p), 75 $\Omega$ , negative sync, RCA jack x 1 (Cb/Pb)/(Cr/Pr) 0.7 V (p-p), 75 $\Omega$ , RCA jack x 2
AUDIO OUT	2.0 Vrms (1 KHz, 0 dB), 600 $\Omega$ , RCA jack (L, R) x 1 /SCART (TO TV)
DIGITAL OUT (COAXIAL)	0.5 V (p-p), 75 $\Omega$ , RCA jack x 1
DIGITAL OUT (OPTICAL)	3 V (p-p), 75 $\Omega$ , Optical Connector x 1

#### ACCESSORIES

Video cable	1
Audio cable	1
Remote control	1
Batteries	2

**Note:** Design and specifications are subject to change prior notice.





[www.NADelectronics.com](http://www.NADelectronics.com)

**©2004 NAD ELECTRONICS INTERNATIONAL  
A DIVISION OF LENBROOK INDUSTRIES LIMITED**

All rights reserved. No part of this publication may be reproduced, stored or transmitted in any form without the written permission of NAD Electronics International

T 524 Manual C Version 12/04